

# Panasonic

ที อี เอ็น พีเอบีเอ็กซ์ / TeN PABX 51/500 หมู่บ้านเสนา 88 ซอย 9 ซอยนวลจันทร์ 17 แขวงนวลจันทร์ เขตบึงกุ่ม กรุงเทพฯ 10240  
ปรึกษา / สอบถาม / แจ้งซ่อม: Hotline: 089-1454237 E-mail: tawintra.kawintra@gmail.com www.tenpabx.com



Smart Hybrid PBX

# KX-NS300

Sales Guide



# One Package Platform for Your Business

The KX-NS300 is a Smart Hybrid PBX suitable for small to medium sized offices. It enables you to provide various solutions with its built-in functions.

Call Centre  
Solution

Smart Hybrid  
System

Preinstalled  
Activation Keys

One Numbered  
Extension

Simplified  
Maintenance

One Package Platform for  
Your Business



**Smart Hybrid PBX  
KX-NS300**

Built-in Voice Mail/  
UC Server

# Smart Hybrid System

The KX-NS300 has sufficient capacity for both legacy and IP ports, and an activation key or expansion cabinet can be used to easily expand the system according to customer needs.

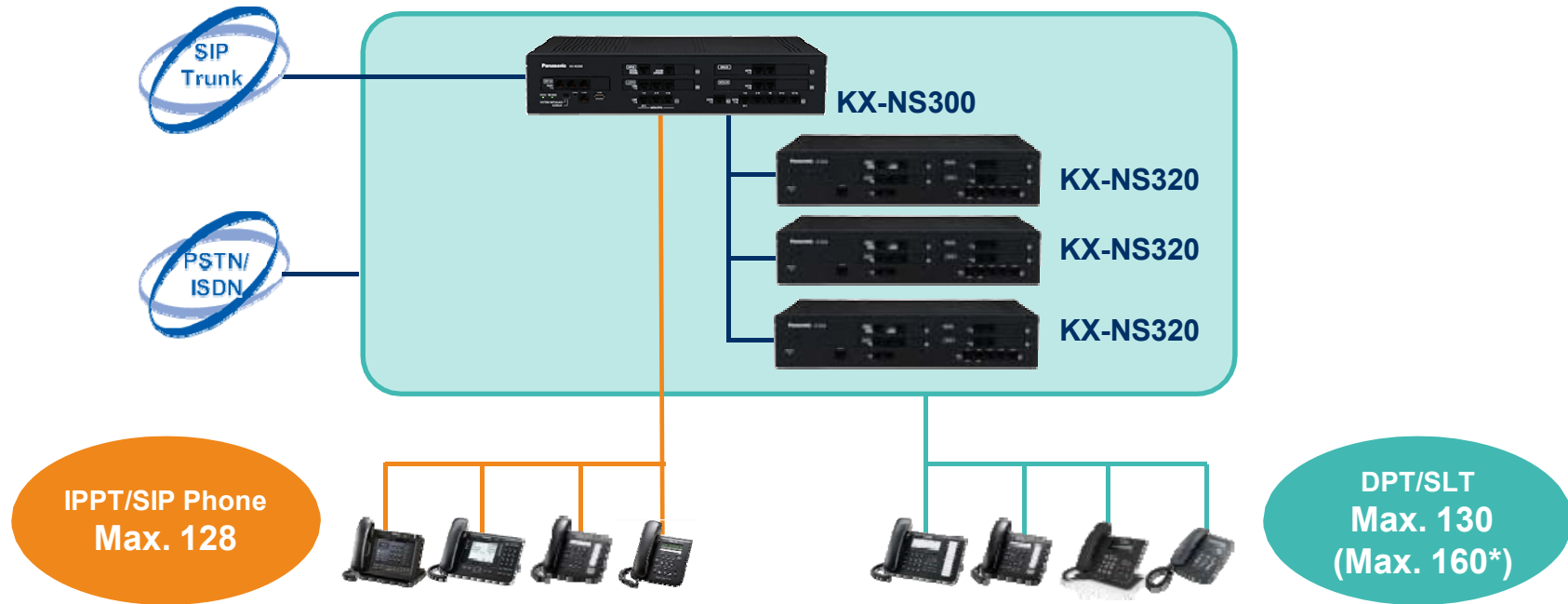

Maximum Trunks and Extensions

Types		Preinstalled	KX-NS300	With 1 KX-NS320	With 2 KX-NS320	With 3 KX-NS320
Legacy	Trunks	6 ch	36 ch	66 ch	96 ch	126 ch
	Extensions (DXDP*)	18	34 (40)	66 (80)	98 (120)	130 (160)
IP	Trunks	N/A	64 ch	64 ch	64 ch	64 ch
	Extensions	N/A	128	128	128	128

\* When Digital XDP is used.

# Preinstalled Activation Keys

The following type and number of activation keys are preinstalled or come with a 60-days free trial on the mother board.

## Smart Hybrid PBX KX-NS300



### Preinstalled Activation Keys

#### *Free Activation Keys*

- 4 IP-PTs user
- 2 ch Unified Messages
- CA Basic-Express for all users

#### *60-days free trial*

- **Unified Messaging**  
(UM/E-mail Client/Message Backup/  
Two-way Recording)
- **Mobile Extension**
- **Communication Assistant**  
(CA PRO/CA Supervisor/CA Operator  
Console/CA Thin Client Server/CSTA  
Multiplexer)
- **3<sup>rd</sup> Party CTI interface**
- **Call Centre Enhancement**

\* DSP is required for some functions.

## Call Centre Solution

The KX-NS300 is designed to be used in call centre environments. Its built-in applications support the basic needs of supervisors at call centres, such as Queue Announcement, Live Status Monitor, Activity Report, Automatic Conversation Recording, and NAS (Network Attached Storage).

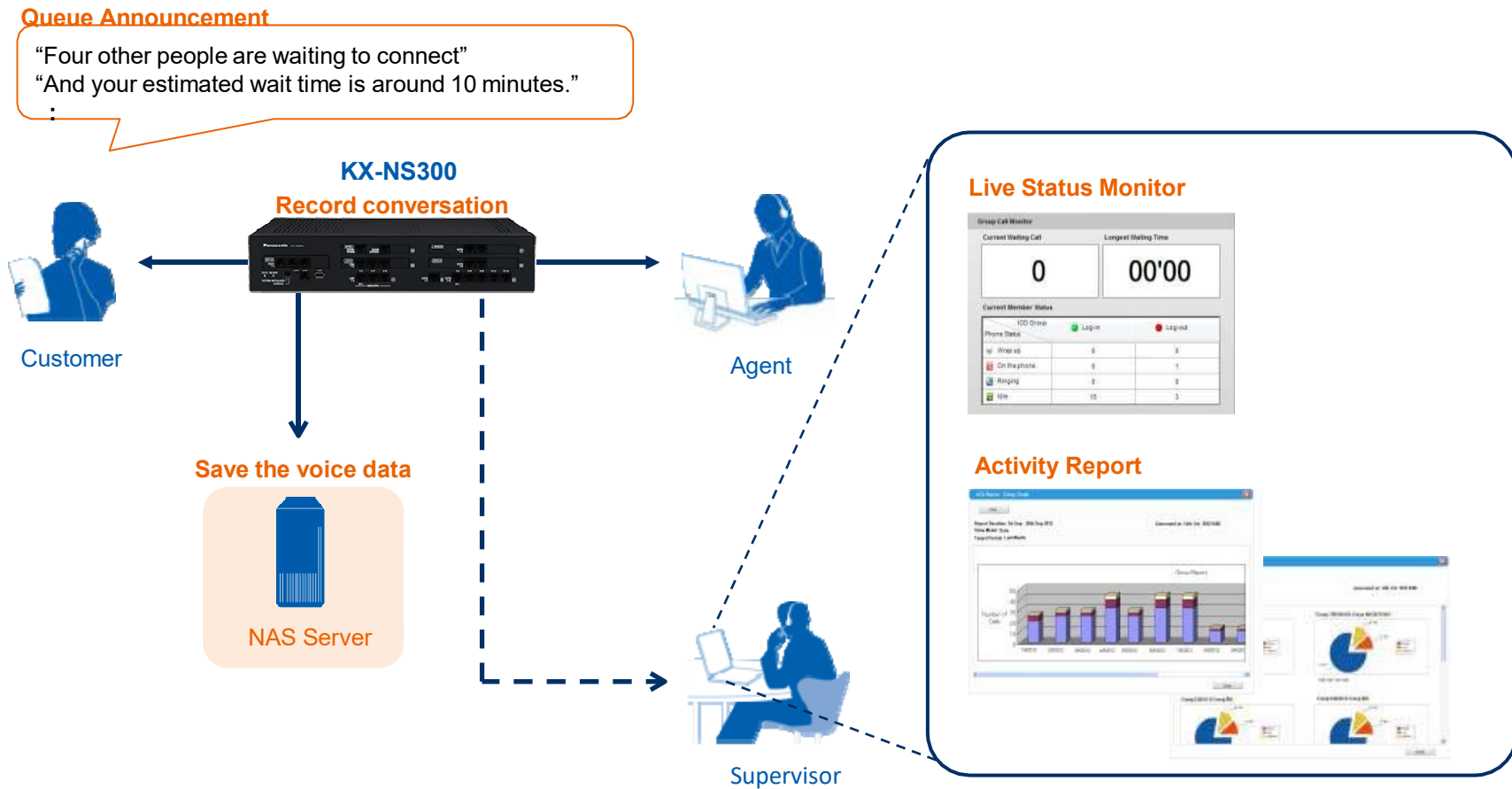

## One Numbered Extension

Up to two extensions can be assigned the same extension number. For example, calls to an extension in the office can be received simultaneously on a softphone on a smartphone. Calls can also be switched between paired phones with a simple operation.

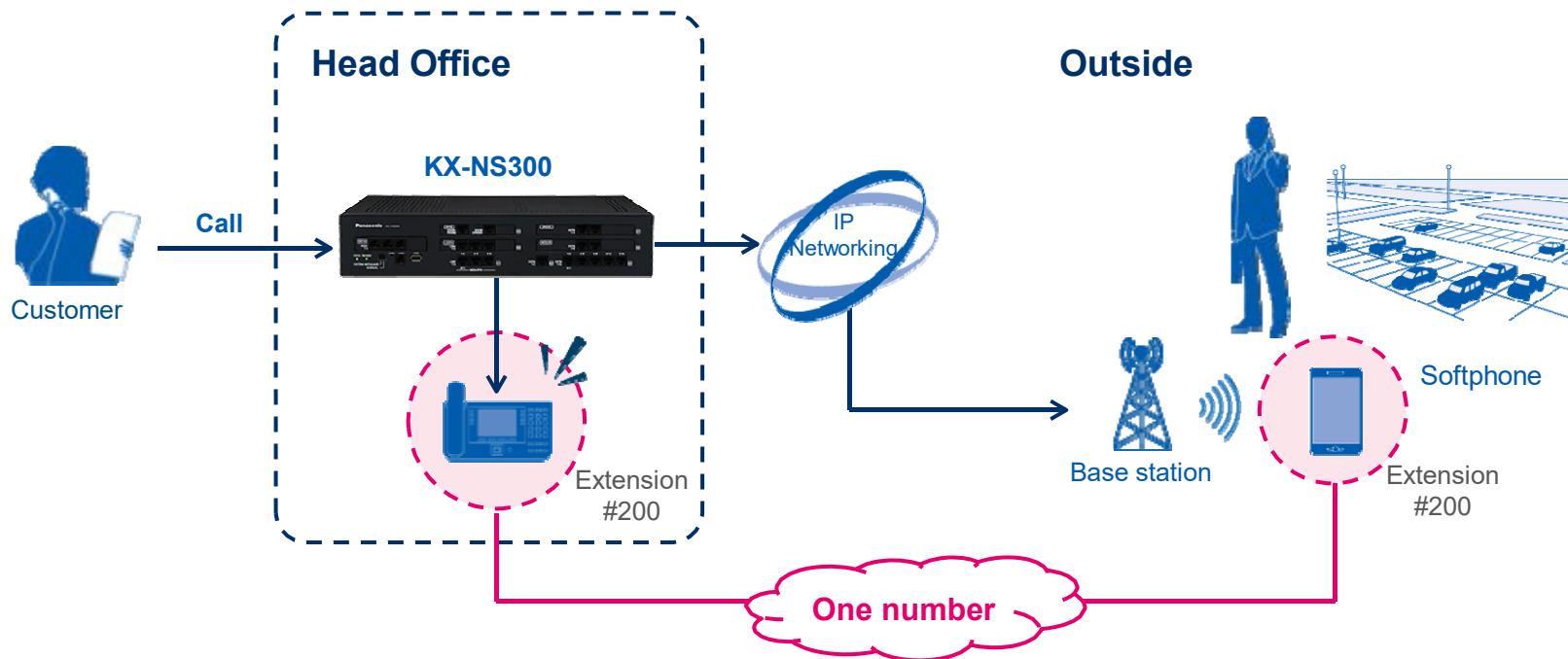

# Introduction - Product Overview

## Simplified Maintenance

The installer can easily program everything related to functions such as PBX and VM by web based console, because the KX-NS300 comes with a built-in web server. Programming can also be performed from remote sites. Users can also use a web based console to configure terminals and the VM mailbox.

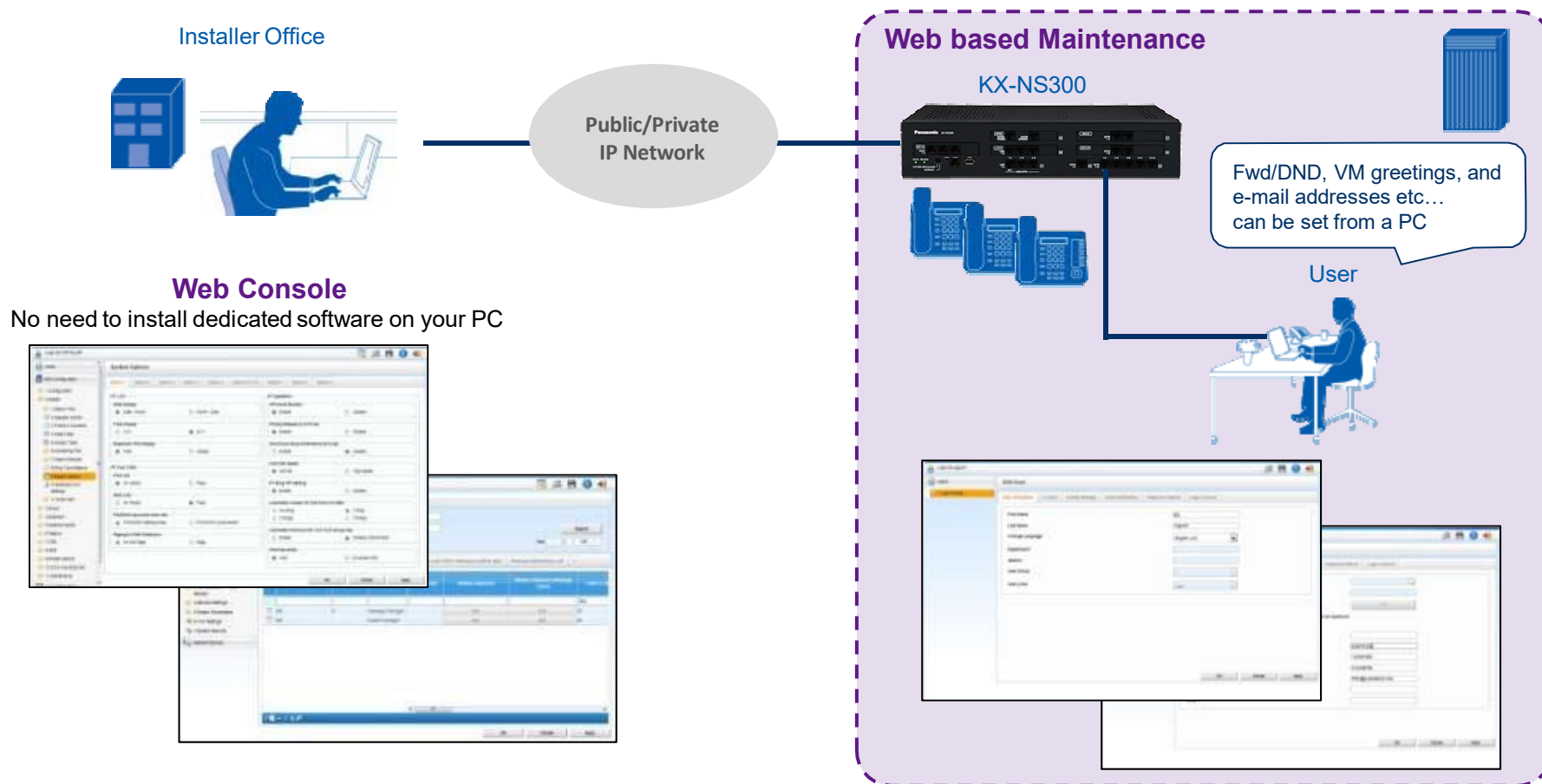

**Web Console**  
No need to install dedicated software on your PC

<Note>  
The programming method is basically same as the KX-TDA/TDW/NCP and KX-TVM.  
Programming can be performed with PTs, in the same way as the KX-TDA100D.

# Built-in Voice Mail/UC Server - Unified Communication

The KX-NS300 has a built-in messaging system that provides voice mail to subscribers. The Unified Messaging system can also provide voice guidance to outside callers, either directing them to their desired destination or to the mailbox of a subscriber, where they can leave a voice message.

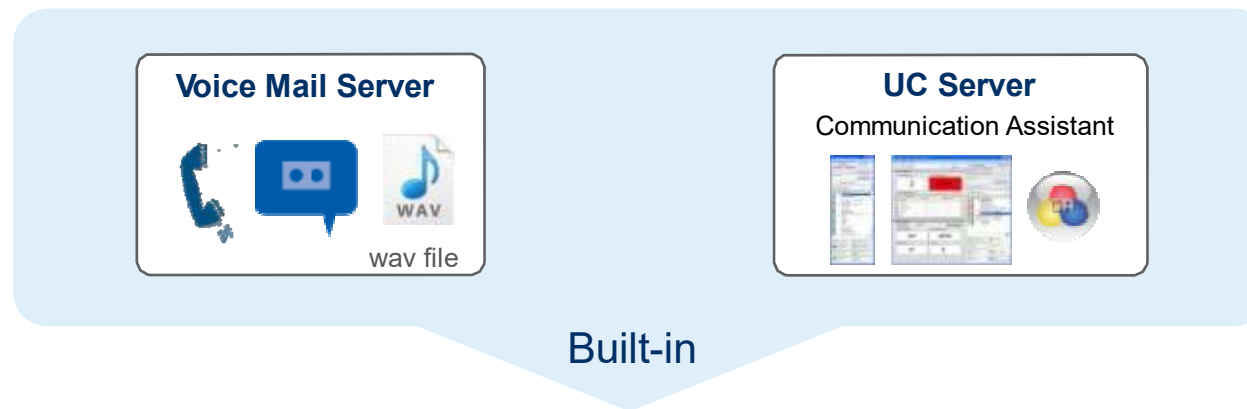

## Smart Hybrid PBX KX-NS300

### E.mail Notification Function

- Voice mail notification
- System alarm notification
- And more....



### MS Outlook & IMAP4 Integration

- Microsoft Outlook plug-in
- IMAP4 protocol supported



# Introduction

## System Connection Diagram

Existing equipment from Panasonic and trunks can continue to be used, and the legacy capacity can easily be expanded simply by connecting an expansion cabinet.

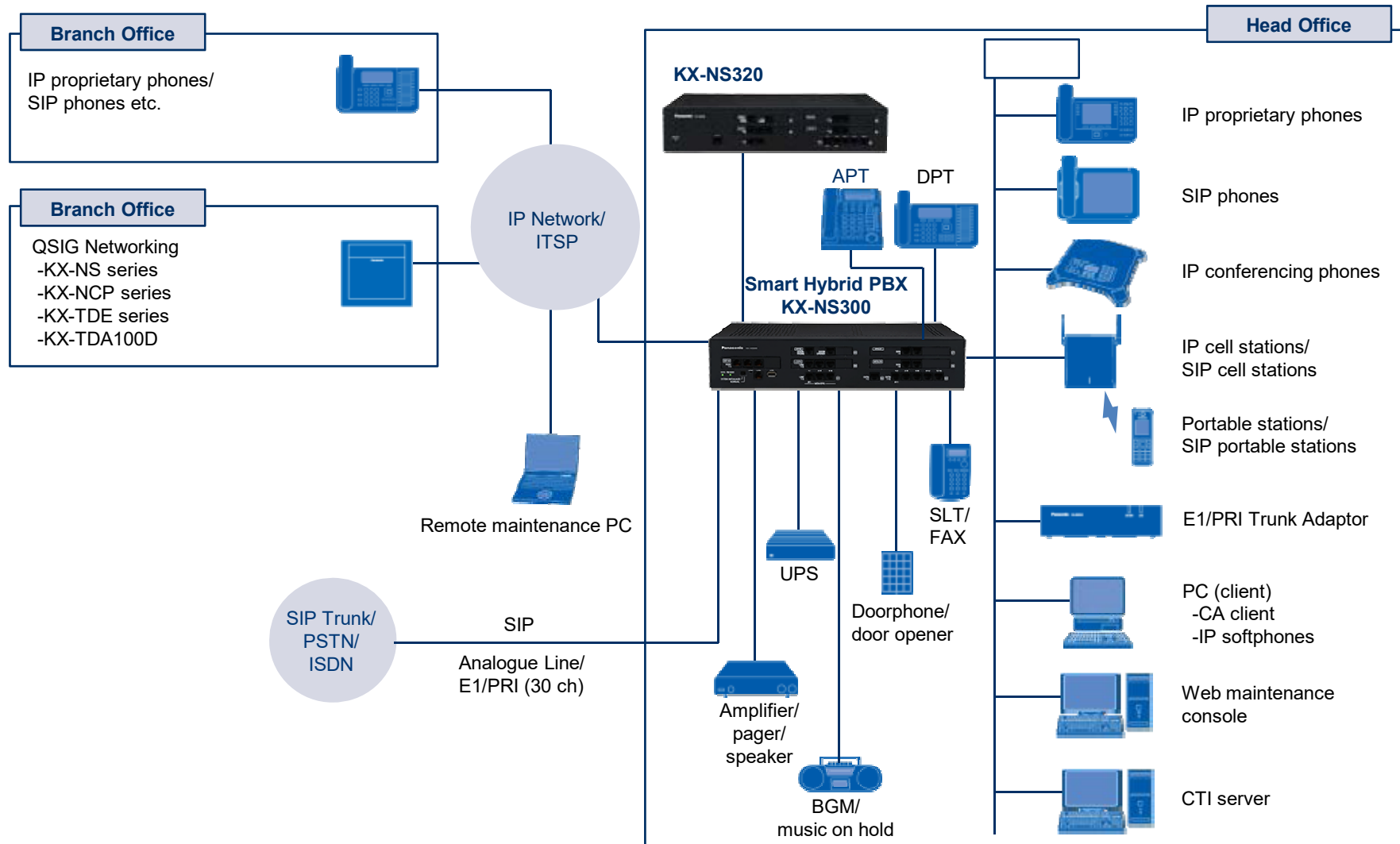

# Why the KX-NS300 ?

Support for various features enhances business productivity. The KX-NS300 offers a Unified Communication System and it is suitable for small to medium sized businesses.

### Smart Hybrid PBX KX-NS300



#### Cost Saving

- Expandability
- Backwards Compatibility
- IP Networking

#### Customer Satisfaction

- Wireless Solution
- Cellular Phone Integration
- Voice Mail Solution

#### Improved Work Efficiency

- Built-in DISA
- Call Centre Solution
- Communication Assistant

# Cost Saving

Head Office

2F

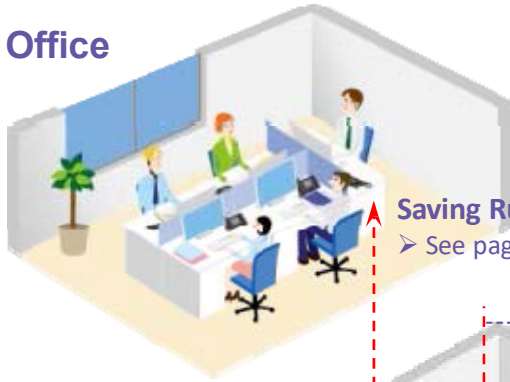

**Saving Running Costs**

➤ See page 23

**Saving Communication Costs**

➤ See page 20

1F



**Backwards Compatibility**

➤ See page 19

**Expandability**

➤ See page 18

Home Office



**Saving on Initial Investment**

➤ See page 22

Remote Office



**Saving Network Costs**

➤ See page 21

# Expandability

The KX-NS300 is expandable with optional cards and expansion cabinets.

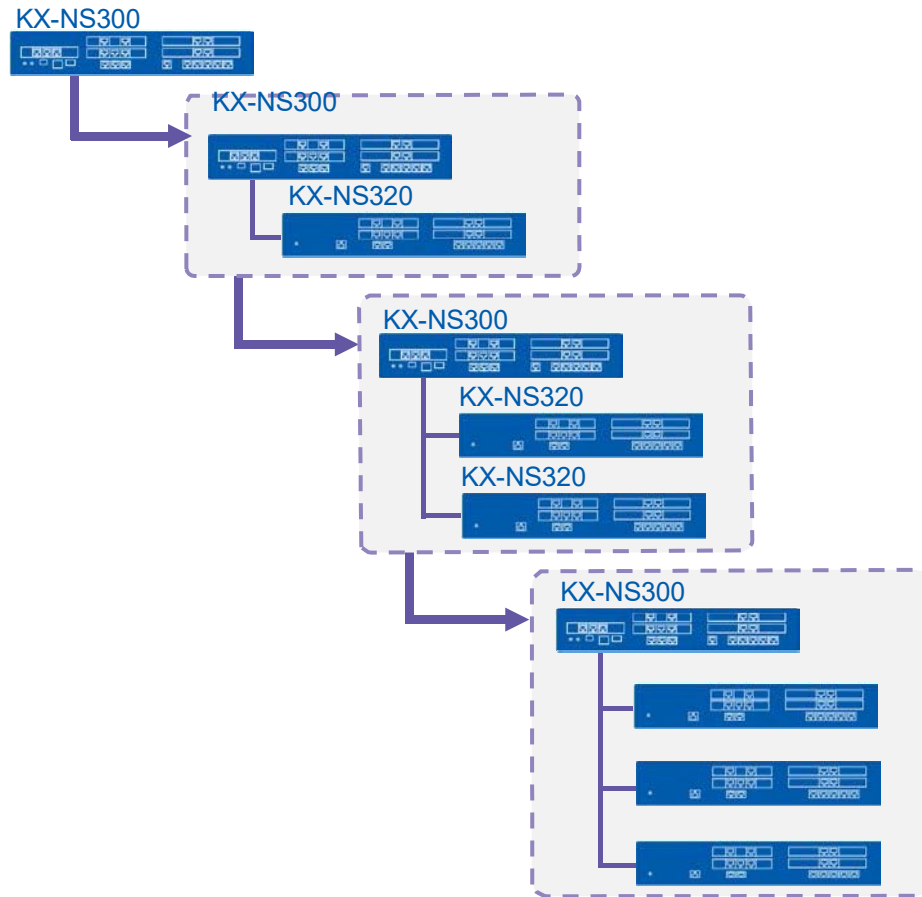

## Features and Benefits

- ▶ You do not need to discard the KX-NS300 to increase capacity in the future.
- ▶ Connecting an expansion cabinet is like connecting the KX-TDA600 and KX-TDA620.

## Recommended for:

- ▶ Growing companies

### Maximum Trunks and Extensions

Types		Preinstalled	KX-NS300	With 1 KX-NS320	With 2 KX-NS320	With 3 KX-NS320
Legacy	Trunks	6 ch	36 ch	66 ch	96 ch	126 ch
	Extensions (DXDP*)	18	34 (40)	66 (80)	98 (120)	130 (160)

\* When Digital XDP is used.

# Backwards Compatibility

Existing DPTs, APTs and SLTs from Panasonic and Trunk can continue to be used, enabling a system to be replaced at a low cost without wasting resources.

## Old System

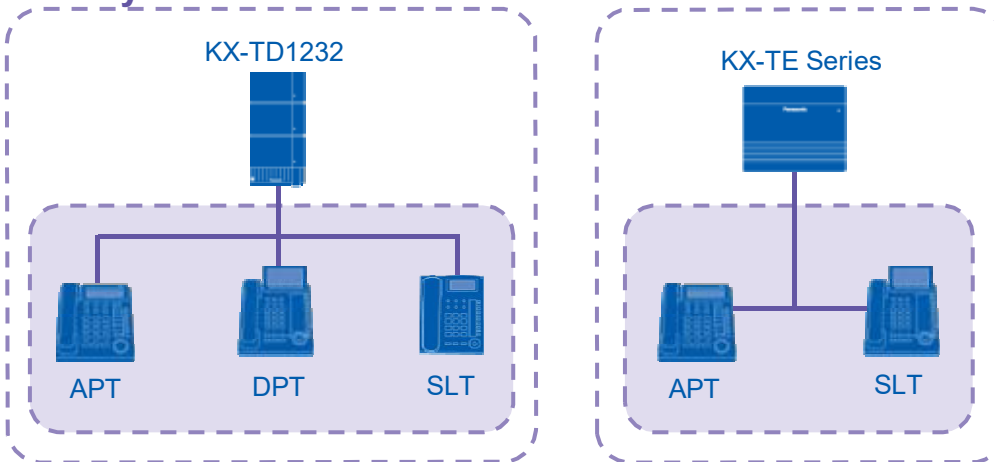

## New System

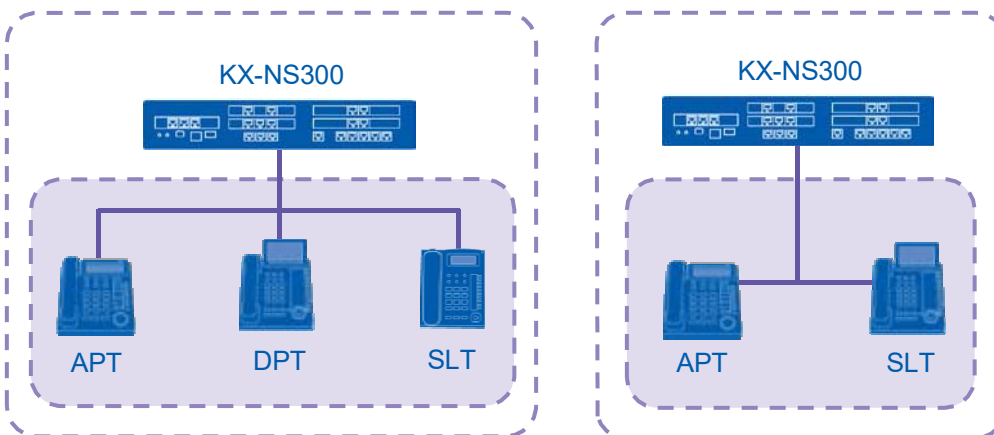

## Features and Benefits

- ▶ Low initial investment costs because the only cost involved is that for purchasing the system.
- ▶ Continue to use an existing KX-T74xx/KX-T75xx.

## Recommended for:

- ▶ Growing companies
- ▶ Companies considering replacing their PBX

# IP Networking -Saving Communication Costs-

The adequate IP capacity of the KX-NS300 enables you to combine both IP and legacy trunks according to your needs, to construct systems that are flexible and cost effective.

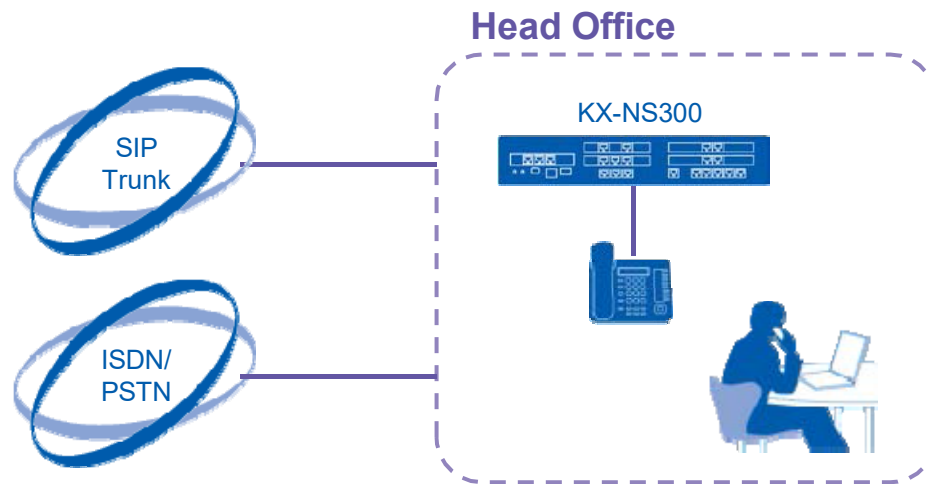

## Features and Benefits

- ▶ Constructing a hybrid system that combines both legacy and IP lines to further reduce costs.

## Recommended for:

- ▶ Companies using an IP/ISDN/PSTN network system.

# IP Networking -Saving Network Costs-

VoIP allows you to talk with your remote offices anywhere in the world without telephone charges using a private IP network.

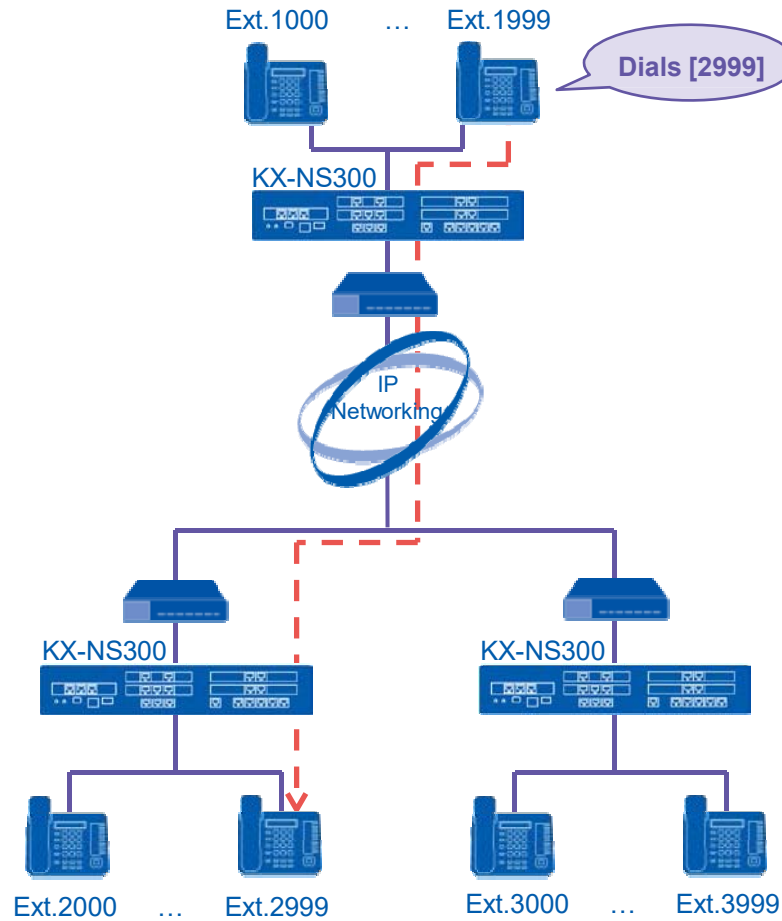

## Features and Benefits

- ▶ Save on call costs.
- ▶ The PBX extension functions can be used across multiple offices.

## Recommended for:

- ▶ Companies which have branches.
- ▶ Companies using an IP network system.

# IP Networking -Saving on Initial Investment-

IP phones can be installed at a remote office without a PBX via an IP network. A VPN is not required. (Built-in Media Relay GW)

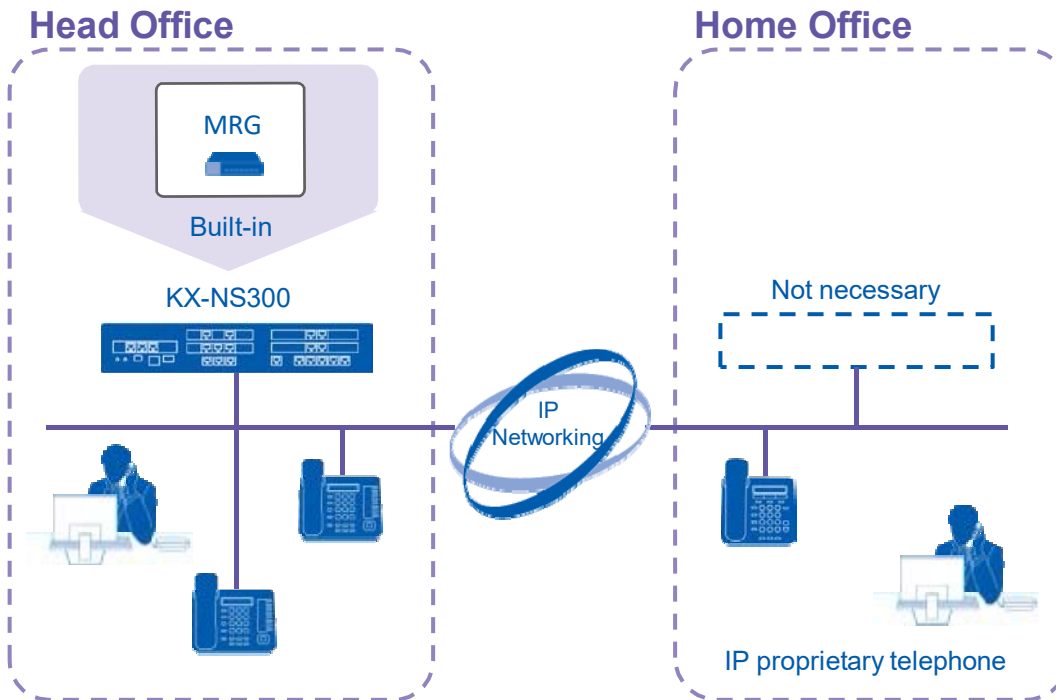

## Features and Benefits

- ▶ No need to install the PBX in branch offices.

## Recommended for:

- ▶ Companies with employees working at home



# IP Networking -Saving Running Costs-

By using IP phones as extensions, there is no need to change the settings of the PBX each time the office layout is changed.

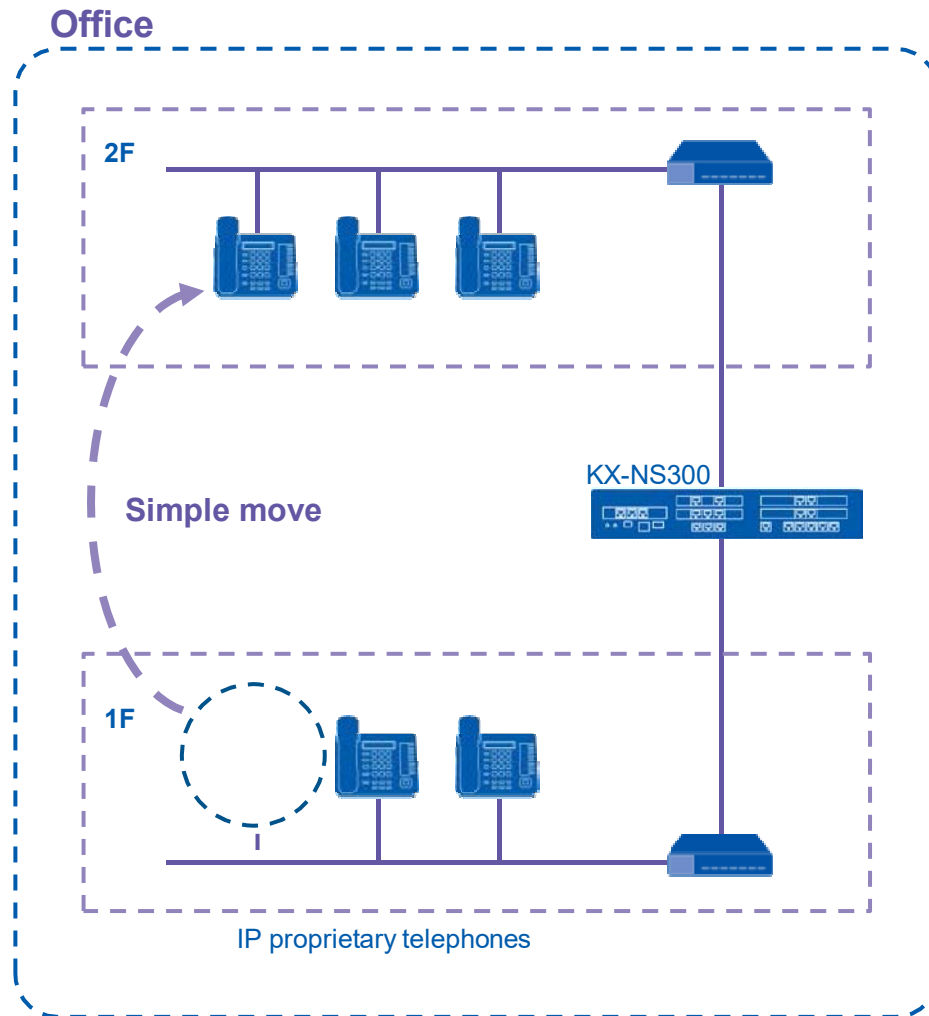

## Features and Benefits

- ▶ No need to change the PBX settings when phones are moved to another place.

## Recommended for:

- ▶ Companies with a need to change their office layout on occasion.
- ▶ Companies which have an LAN network system.
- ▶ Growing companies

# Customer Satisfaction

## 3F: Warehouse



**Tough Type Handset**  
➤ See page 28

**DECT Paging**  
➤ See page 27

**Multi Zone**  
➤ See page 25

## Branch Office

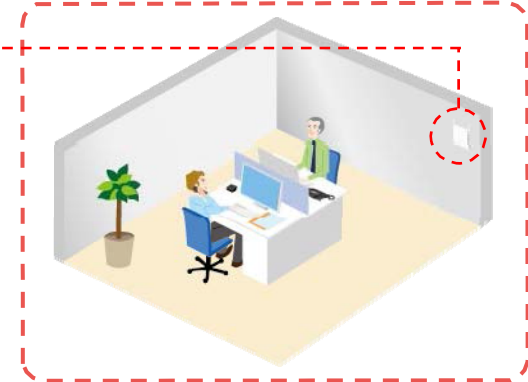

## 2F: Office

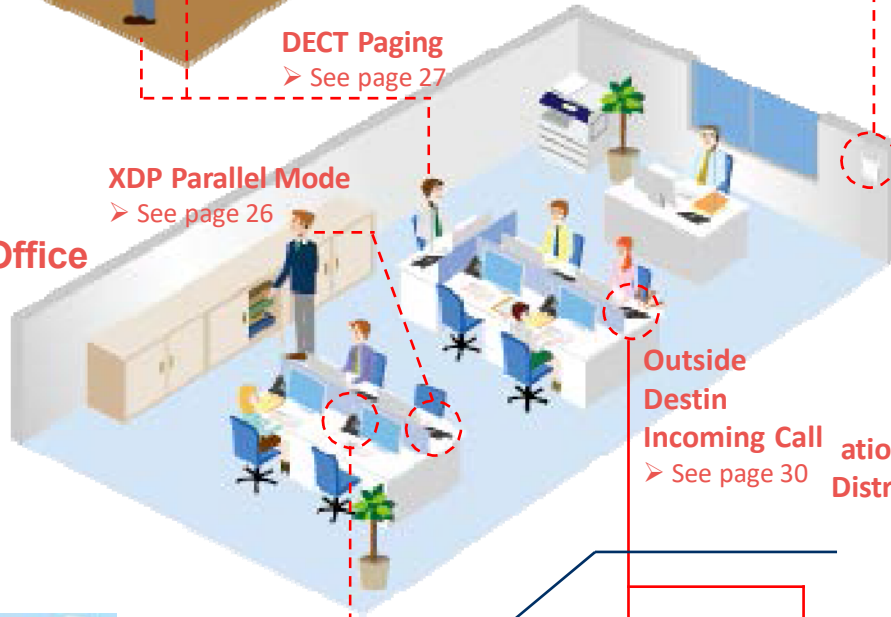

**XDP Parallel Mode**  
➤ See page 26

**Outside Destin Incoming Call**  
➤ See page 30

**ations in Distribution Groups**

## 1F: Office

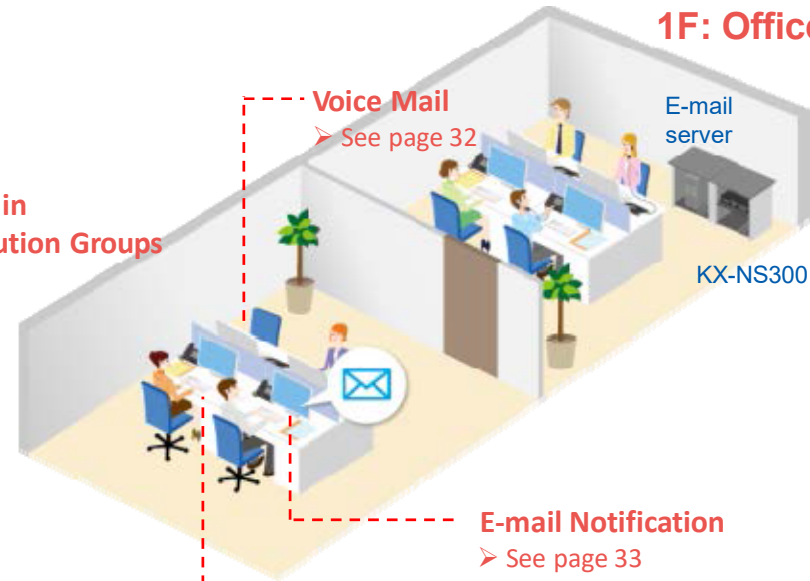

**Voice Mail**  
➤ See page 32

**E-mail Notification**  
➤ See page 33

**MS Outlook & IMAP4 Integration**  
➤ See page 34

**One Numbered Extension**  
➤ See page 29, 31

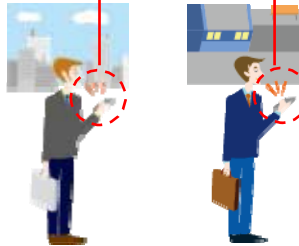

# Wireless Solution -Multi Zone-

You can receive customer calls wherever you are in the company. Automatic hand-over allows smooth conversations on the move.

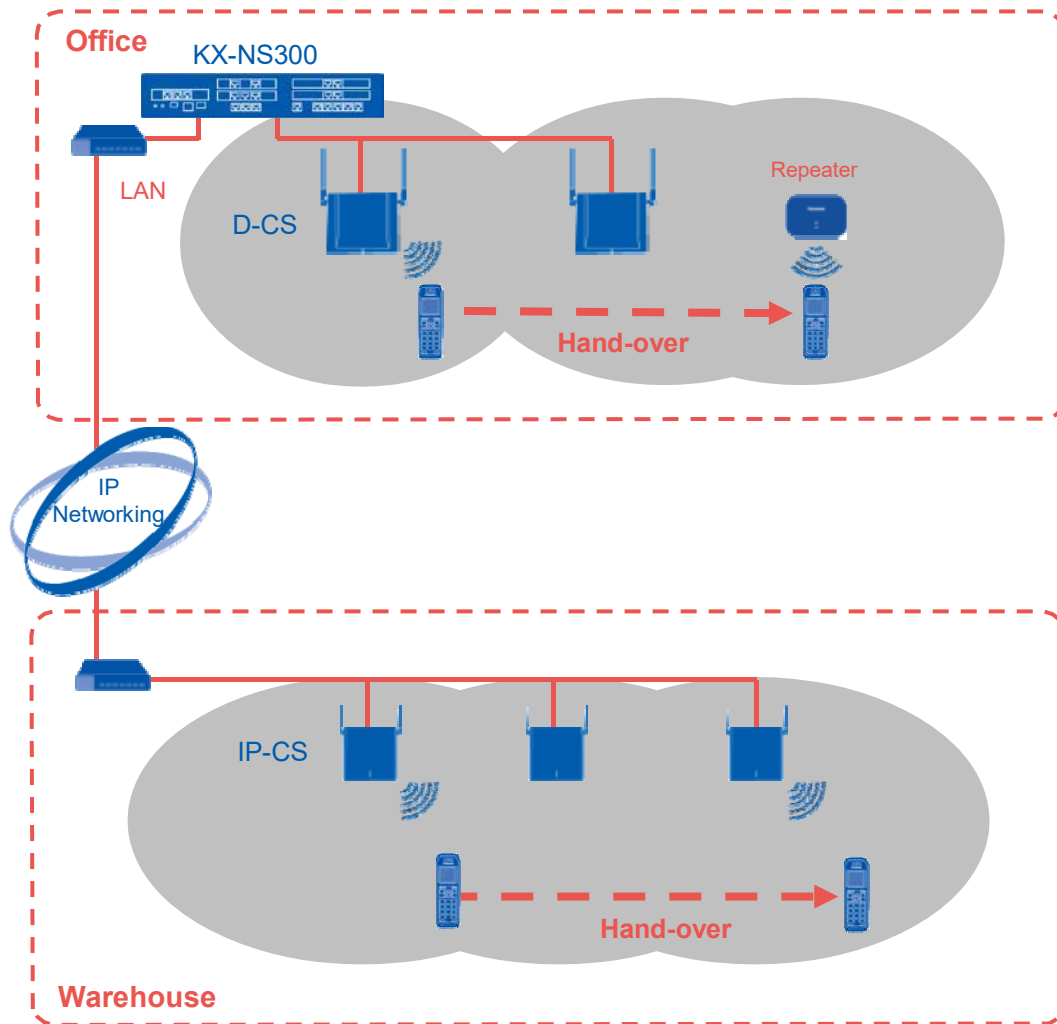

## Features and Benefits

- ▶ On-site employees: efficient because it is not necessary to return to the office to make a call.
- ▶ Call receptionists: less trouble because the person to transfer the call to can be reached anywhere
- ▶ Customers: improved customer satisfaction with less customer waiting because calls can be quickly transferred to the wireless handset of the person in charge.
- ▶ Repeater Use: Call zone expansion can be enabled at a low cost because it is not necessary to wire extra cell stations to the PBX.
- ▶ Wireless solutions can be easily installed at remote sites using an IP network.

## Recommended for:

- ▶ Dedicated employees stationed for receiving phone calls
- ▶ Employees often away from their desks

## Wireless Solution -XDP Parallel Mode-

Both a proprietary phone on the user's desk and a portable station can be called simultaneously using a single extension number.

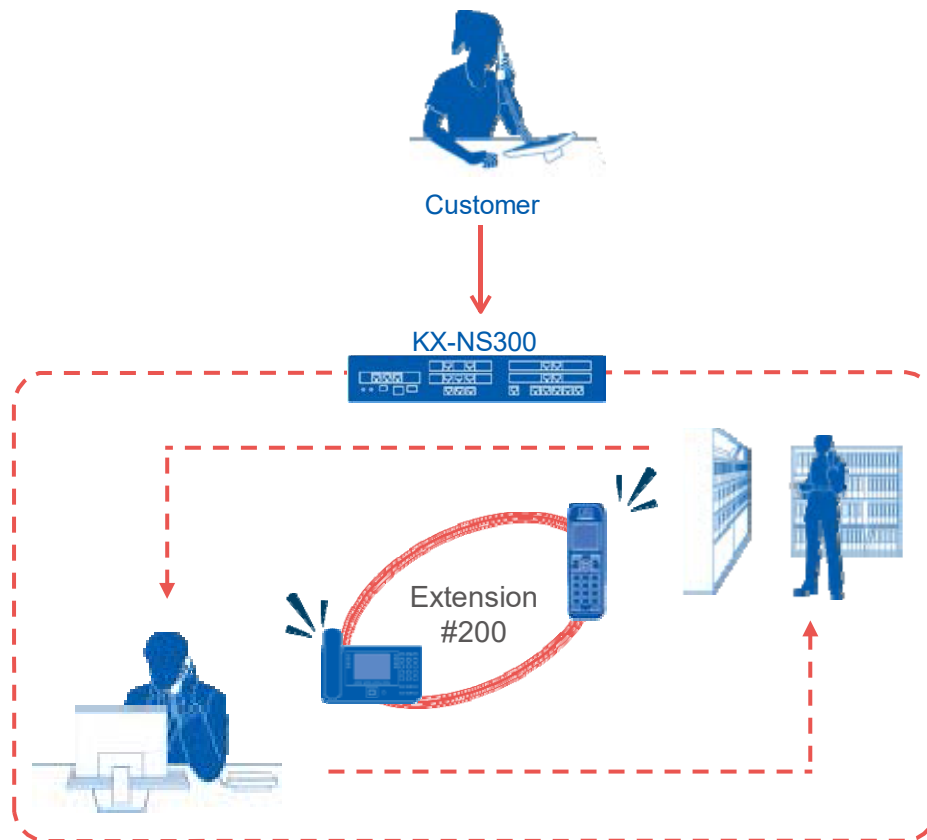

### Features and Benefits

- ▶ Calls can be switched between desk phones and portable stations with a simple operation during conversations.
- ▶ Switch from DECT simply by picking up the handset of your desk phone when you return to your seat.
- ▶ Switch to DECT simply by pressing a button on the portable station when you leave your seat.

### Recommended for:

- ▶ Employees often going back and forth from their desk to make calls
- ▶ For executive rooms and reception corners

# Wireless Solution -DECT Paging-

Paging can be performed between a maximum of 32 DECT wireless extensions. You can give directions to staff around the premises. This enables customers to be quickly responded to.

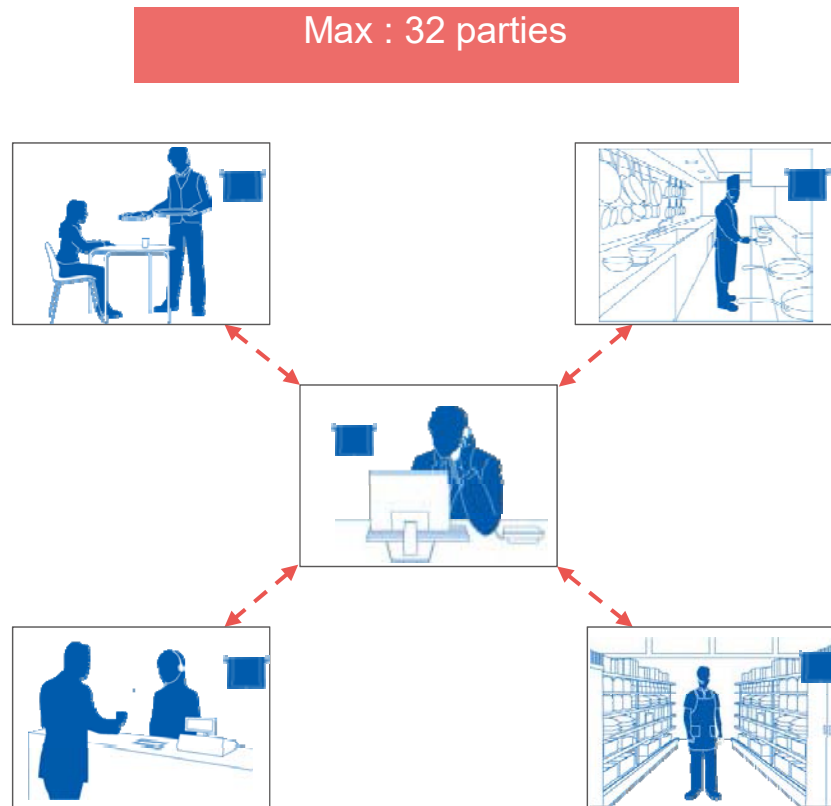

## Features and Benefits

- ▶ Conversations between staff can be shared.
- ▶ Multiple people can be called at the same time.
- ▶ Contact made anywhere within the coverage area.

## Recommended for:

- ▶ Hotel, healthcare, or retail customers, etc. that require speedy sharing of information to share instructions with the relevant parties at the same time.
- ▶ Companies with relevant parties in different locations.

<Note>  
The availability of this function depends on the portable station model.

## Wireless Solution -Tough Type Handset-

Dust resistance and water resistance for use in locations with high amounts of dust and humidity (IP65 Compliant). This enables customer calls to be received in damp or dusty locations without concern.

Tough type model  
KX-TCA385



IP5  
Splash  
proof

IP6  
Dust  
resistance



### Features and Benefits

- ▶ In humid or dusty environments, repair costs can be reduced compared to non-resistant models.
- ▶ Water resistance  
IP5: Water resistance, protection against splashed water.
- ▶ Dust resistance  
IP6: Dust resistance, no invasion of dust.

### Recommended for:

- ▶ Environments with warehouses and garages
- ▶ Locations near kitchens, baths, etc.

# Cellular Phone Integration -Receive a Call-

When your customer calls your office phone number, both your phone at the office and your cellular phone can ring at the same time. You can receive customer calls both inside and outside the company.

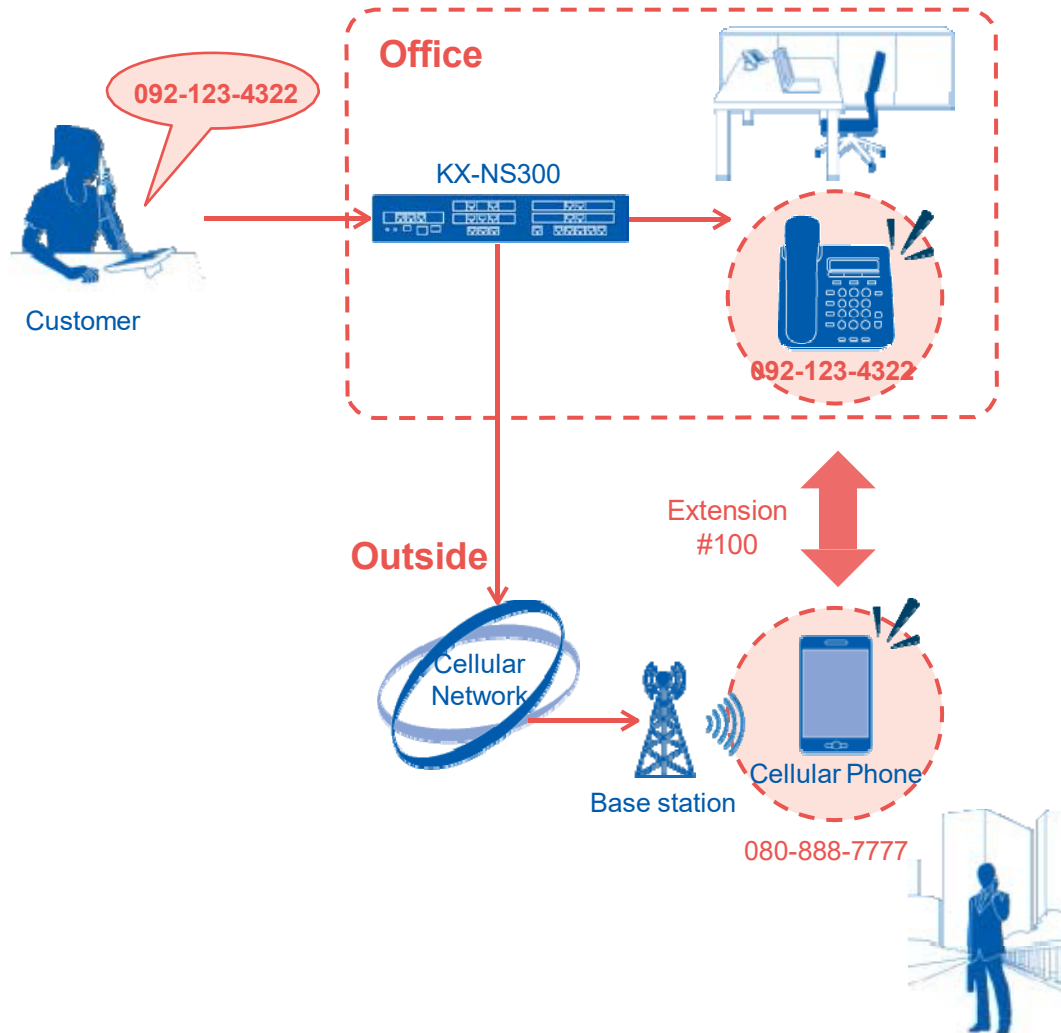

- ### Features and Benefits
- ▶ You only need to inform the customer of your office phone number.
  - ▶ Calls can be received with both a cellular network or IP network.

- ### Recommended for:
- ▶ Businesspeople that work both inside and outside the company.

# Cellular Phone Integration -Outside Destinations in Incoming Call Distribution Groups-

Up to four cellular phones can be assigned as members of an Incoming Call Distribution (ICD) group, and receive calls to the group. Users who are not busy can quickly respond to customer calls.

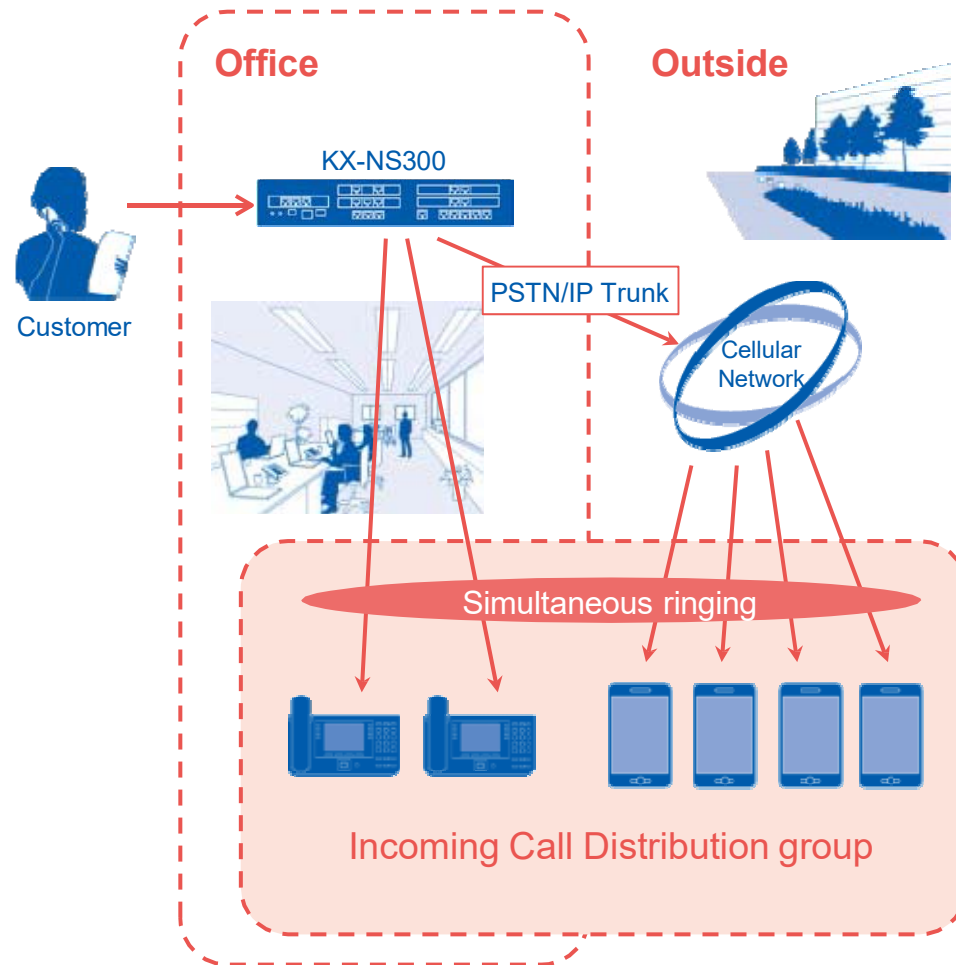

## Features and Benefits

- ▶ When a customer calls, both extensions and a registered cellular phone can be made to ring, enabling the call to be received with either phone.
- ▶ Up to four cellular phones can be registered to an ICD group with other wired extensions.

## Recommended for:

- ▶ Companies with not many people available to answer the phone
- ▶ Companies with many employees working outside of the office



# Cellular Phone Integration -Make a Call-

## Smart Remote Extension

You can install IP telephones in remote locations, such as the outside, without a special router. And up to two IP extensions can be assigned the same extension number. (One Numbered Extension)

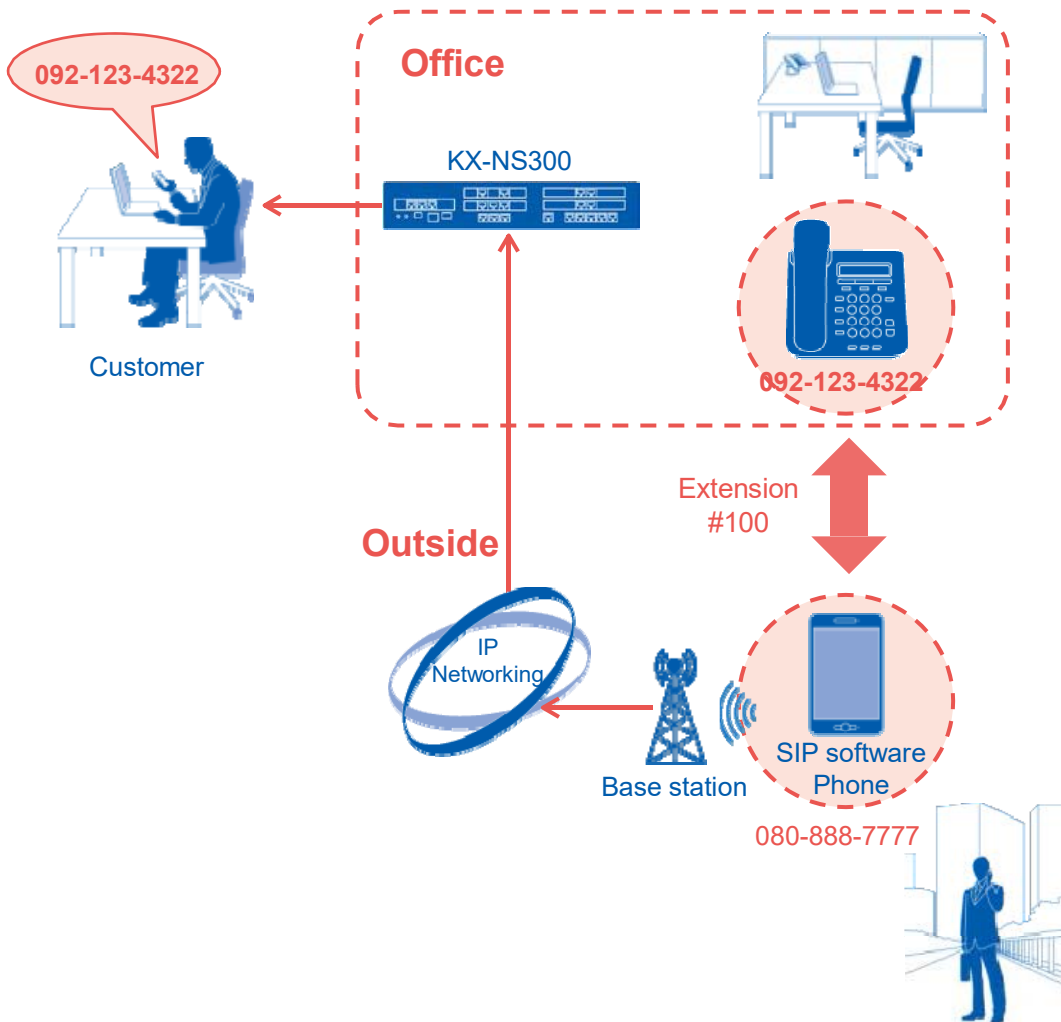

### Features and Benefits

- ▶ Extensions can be configured remotely and easily.
- ▶ You can use smartphones as extensions.
- ▶ Use an SIP software phone to call customers when you are away from the office without any additional fees.
- ▶ The customer is notified of your office phone number instead of the number of your cellular phone.

### Recommended for:

- ▶ Businesspeople that work both inside and outside the company.

# Voice Mail Solution -Voice Mail-

Customers can leave voice mail if they call when you are away.

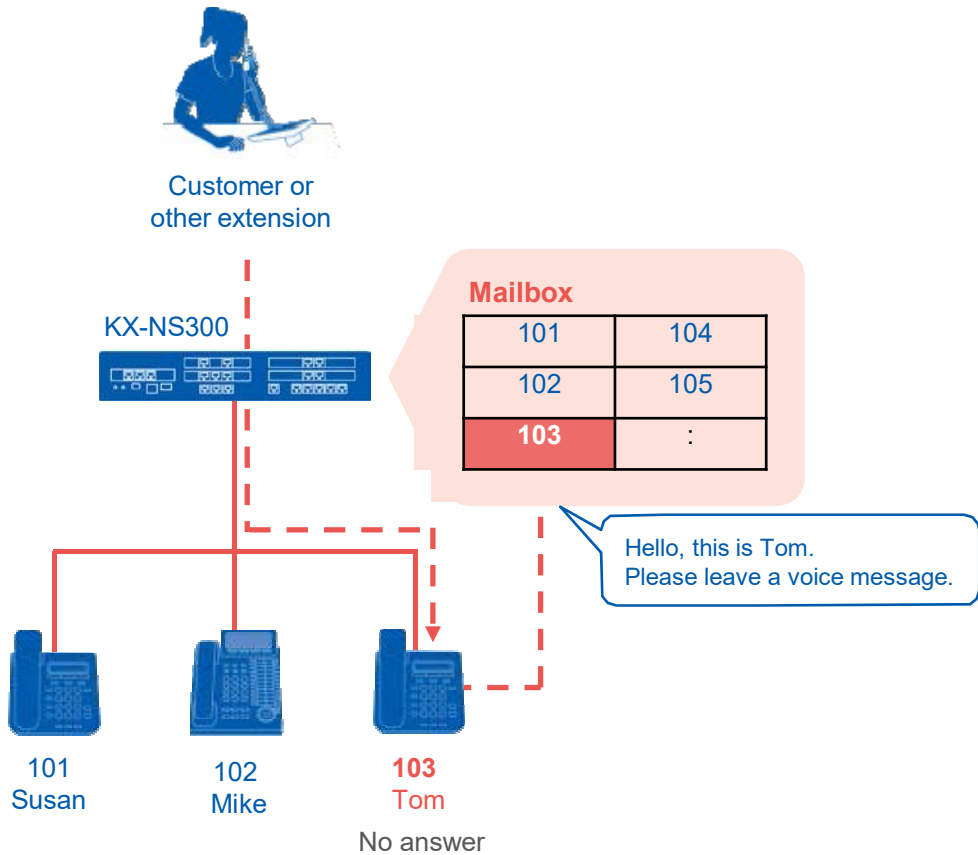

## Features and Benefits

- ▶ Record a maximum of 24 channels at the same time.
- ▶ Record up to 400 hours.

## Recommended for:

- ▶ Companies which get calls outside of business hours.
- ▶ Employees who work away from the phone or out of the office.

# Voice Mail Solution -E-mail Notification-

The KX-NS300 sends an e-mail to the corresponding user when they have new messages. Missed calls without a voice message also can be e-mailed. This enables you to contact customers quickly.

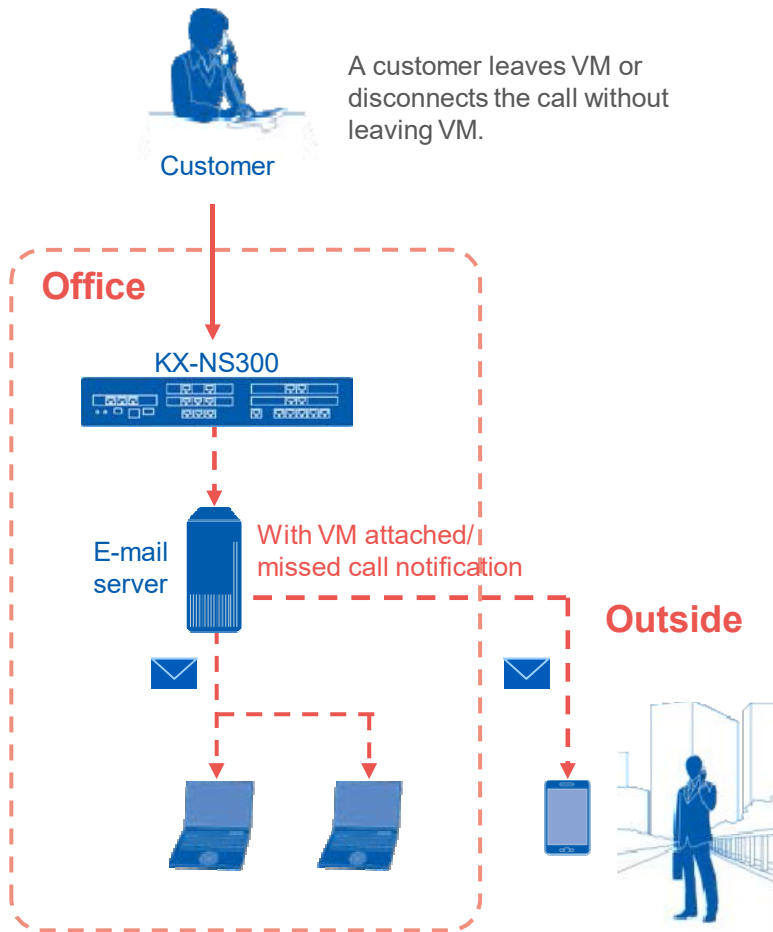

## Features and Benefits

- ▶ The notification contains information regarding the sender of the message, the length of the message, the number of messages, and a callback number.

## Recommended for:

- ▶ Companies which get calls outside of business hours.
- ▶ Employees who work away from the phone or out of the office.

# Voice Mail Solution -MS Outlook & IMAP4 Integration-

The KX-NS300 works as a voice IMAP4 server, so users can access the content of their mailboxes using a common e-mail client which supports the IMAP4 protocol. With the Microsoft Outlook plug-in, users can access the content of their mailboxes through Microsoft Outlook in the same way as they do for e-mail.

### With IMAP integration, users can do the following:

- Play back voice messages
- Save voice data to their PCs
- Delete voice messages

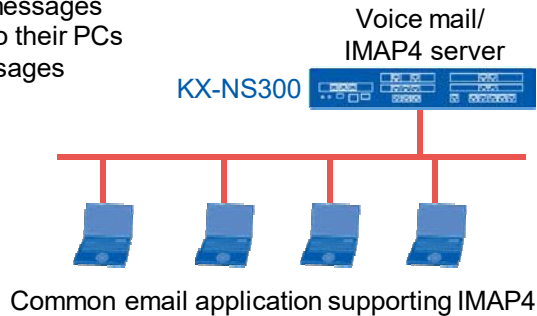

### With the Outlook plug-in, users can do the following:

- Play back voice messages
- Record and send voice messages
- Forward and reply to messages
- Call back the sender of a message
- Export voice message data
- Attach voice messages to other e-mail messages



## Features and Benefits

- ▶ Users can easily listen to and transfer voice messages.
- ▶ A UC environment that includes voice messages, e-mail, an SNS, and a scheduler can be constructed with Outlook alone.

## Recommended for:

- ▶ Companies that require information to be shared between agents
- ▶ Companies using Outlook
- ▶ Companies that want to construct an efficient office environment that integrates various communication methods

## Call Centre

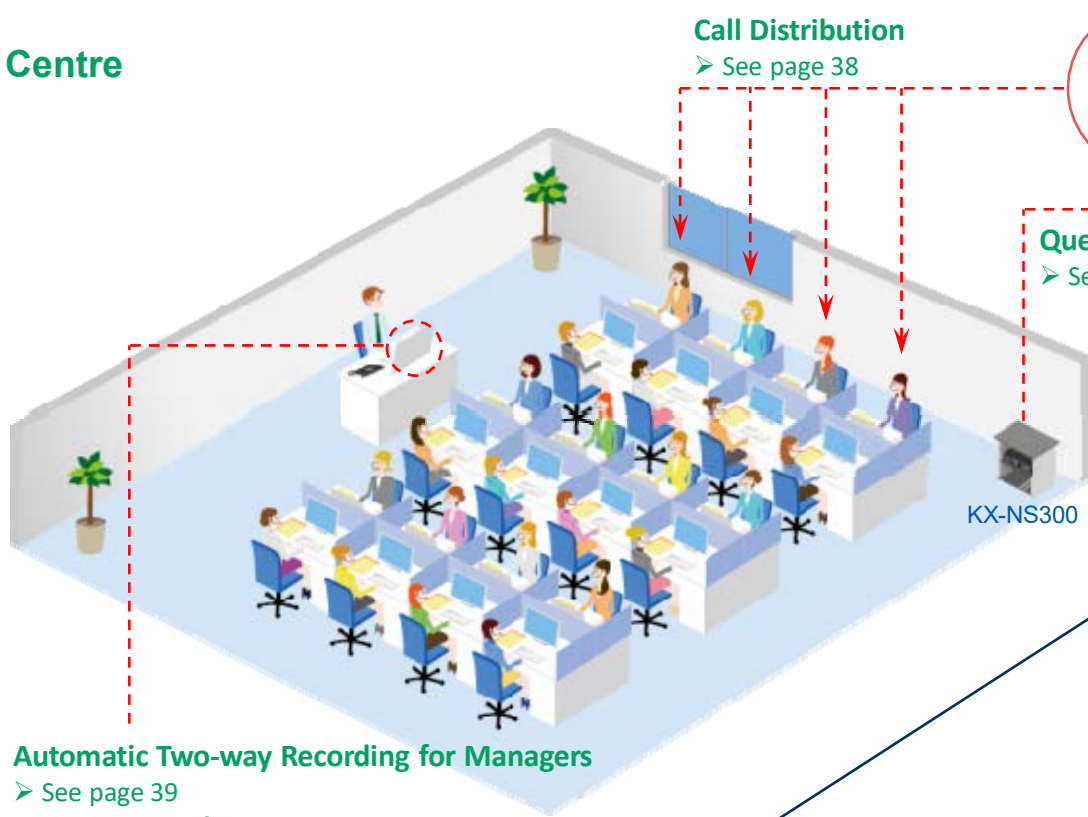

### Automatic Two-way Recording for Managers

➤ See page 39

### NAS Supported

➤ See page 40

### Activity Monitor

➤ See page 41

### Activity Report

➤ See page 42

## Office

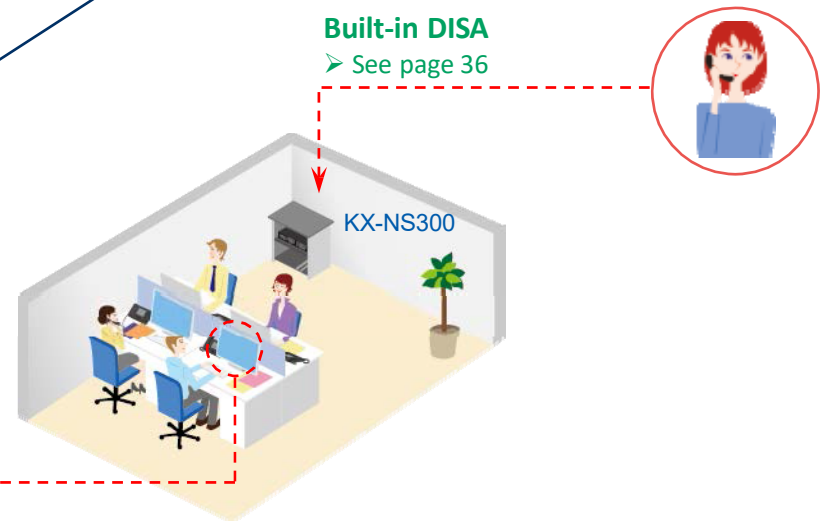

# Built-in DISA

Transfer customer calls without an operator.

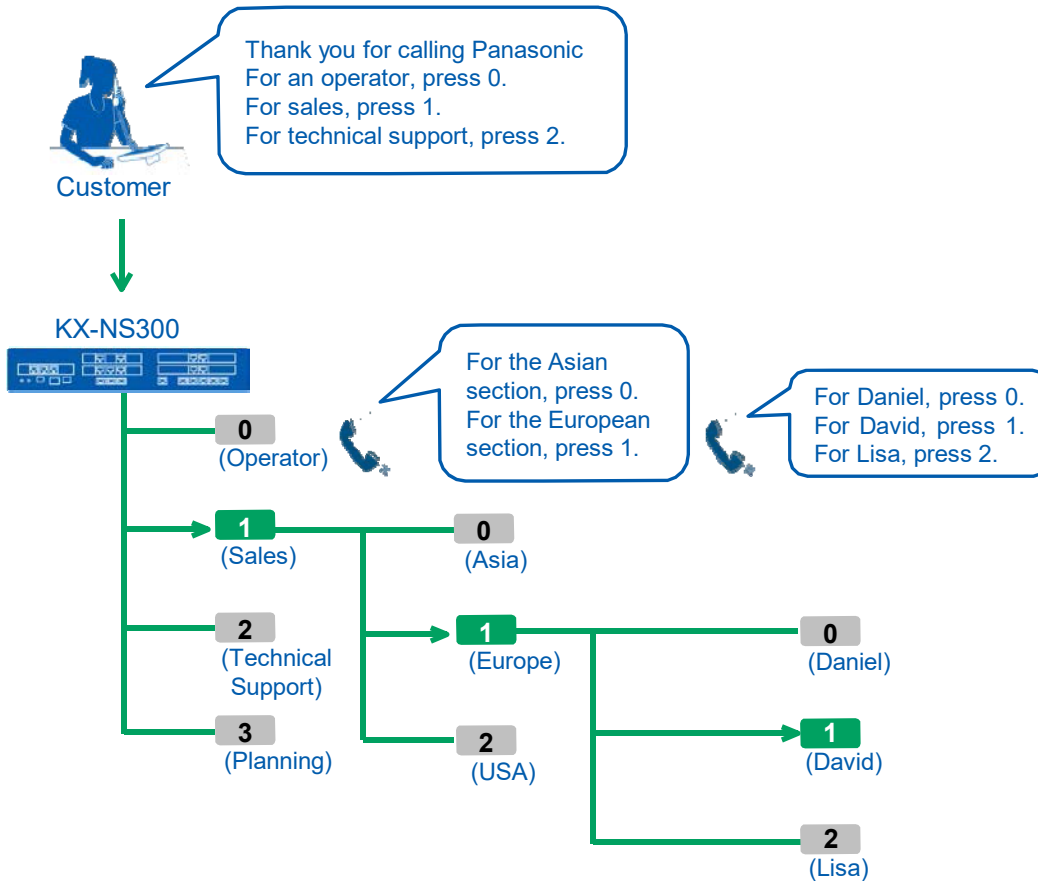

## Features and Benefits

- ▶ These features provide users with greater flexibility and increase staff productivity.
- ▶ Human resources currently used for operators can be assigned other work.

## Recommended for:

- ▶ Companies which have various departments.
- ▶ Companies which get specific calls which need to be answered by the person in charge.



# Call Centre Solution -Call Distribution-

The KX-NS500 provides a variety of call distribution options.

### Ring all extensions

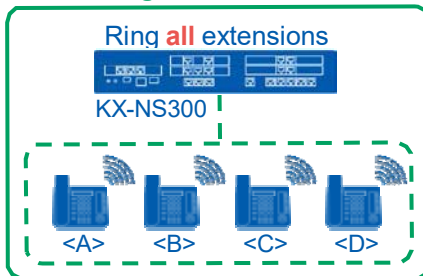

### UCD (Uniform Call Distribution)

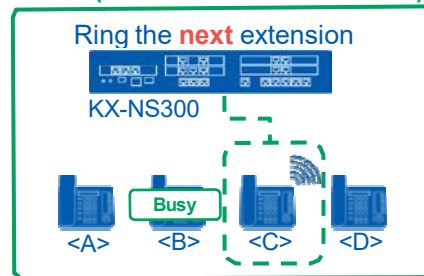

### ACD (Automatic Call Distribution)

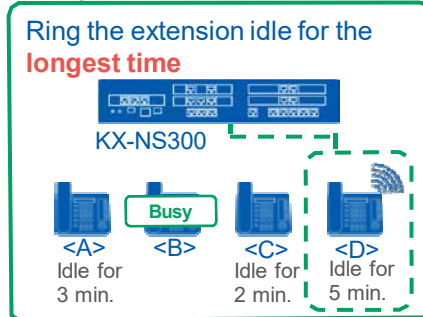

### Overflow Extension

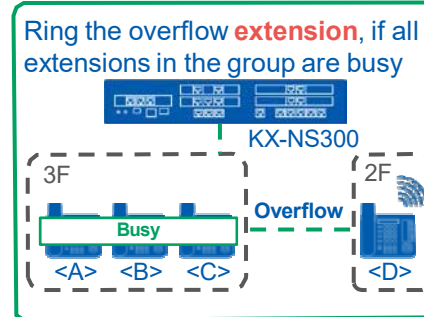

### Priority Hunting

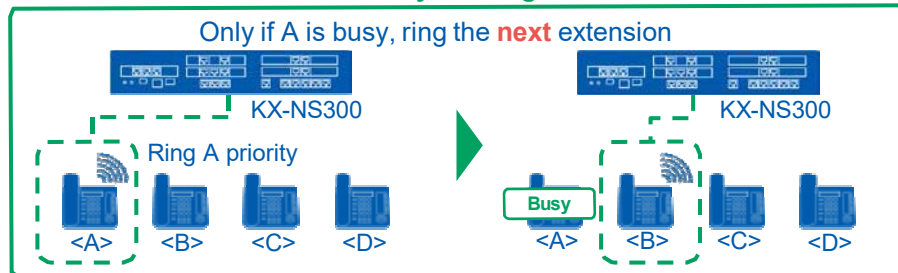

Programmed Order: A⇒B⇒C⇒D (except with "Ring all extensions")

## Features and Benefits

- ▶ Various types of call distribution enables customer waiting time and stress to be reduced.
- ▶ For example, when a call comes in to a busy line or an unattended phone, the system can distribute it to another extension, a voice mail system, a home or mobile telephone, or other pre-programmed destinations.

## Recommended for:

- ▶ Companies which want to perform efficient call operations without installation of a special and expensive call centre system

## Login / Logout

Allows agents to log into a ring group with an ID number. All calls received by the agent are displayed on the report until the agent has logged out.





# Call Centre Solution -Automatic Two-way Recording for Managers-

Calls to and from all extensions can be automatically recorded to a mailbox.

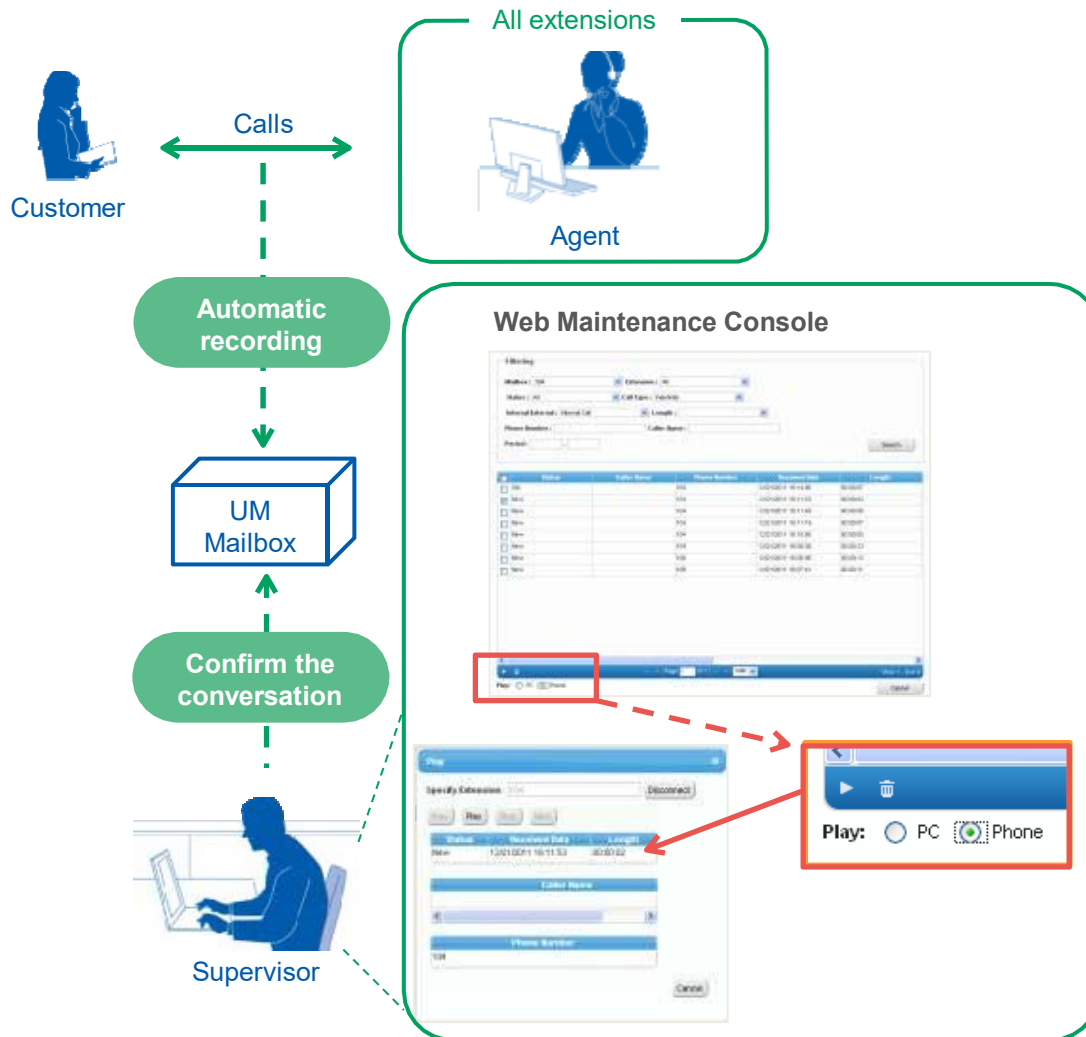

## Features and Benefits

- ▶ Extensions can be assigned to a supervisor.
- ▶ Supervisors can listen to the recorded conversation through the Web Maintenance Console.
- ▶ Recorded data can be played back anytime the supervisor requires.
- ▶ Recorded data can be used to understand problems with agents, and then instruct those agents to improve customer service.

## Recommended for:

- ▶ Companies that want to educate employees
- ▶ Companies receiving increasing numbers of complaints from customers

# Call Centre Solution -NAS Supported-

Since the KX-NS300 supports connecting with NAS (Network Attached Storage), it can make a backup of voice data to NAS to enable supervisors to listen to the saved data when required.

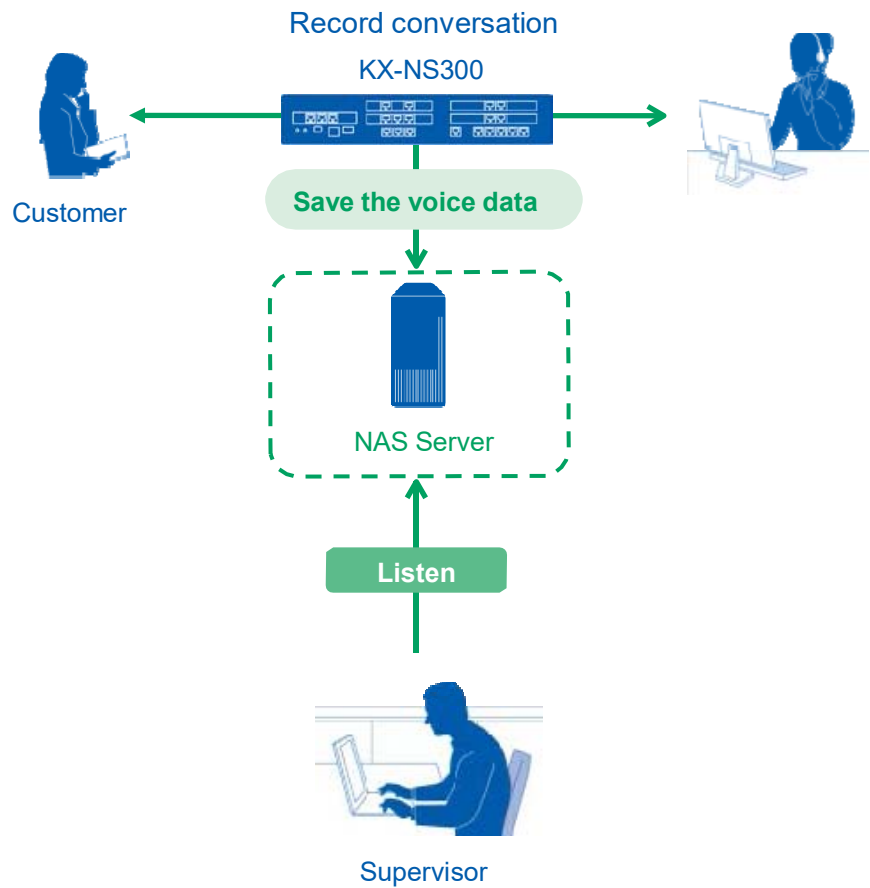

## Features and Benefits

- ▶ Supervisors can use the backup data to understand problems or opportunities relating to customer service.

## Recommended for:

- ▶ Companies that often have the need to listen to the content of conversations again
- ▶ Companies that want to improve the customer handling of agents
- ▶ Companies that want to share information between agents

# Call Centre Solution -Activity Monitor-

The call centre supervisor can monitor the status of each agent and extension group.

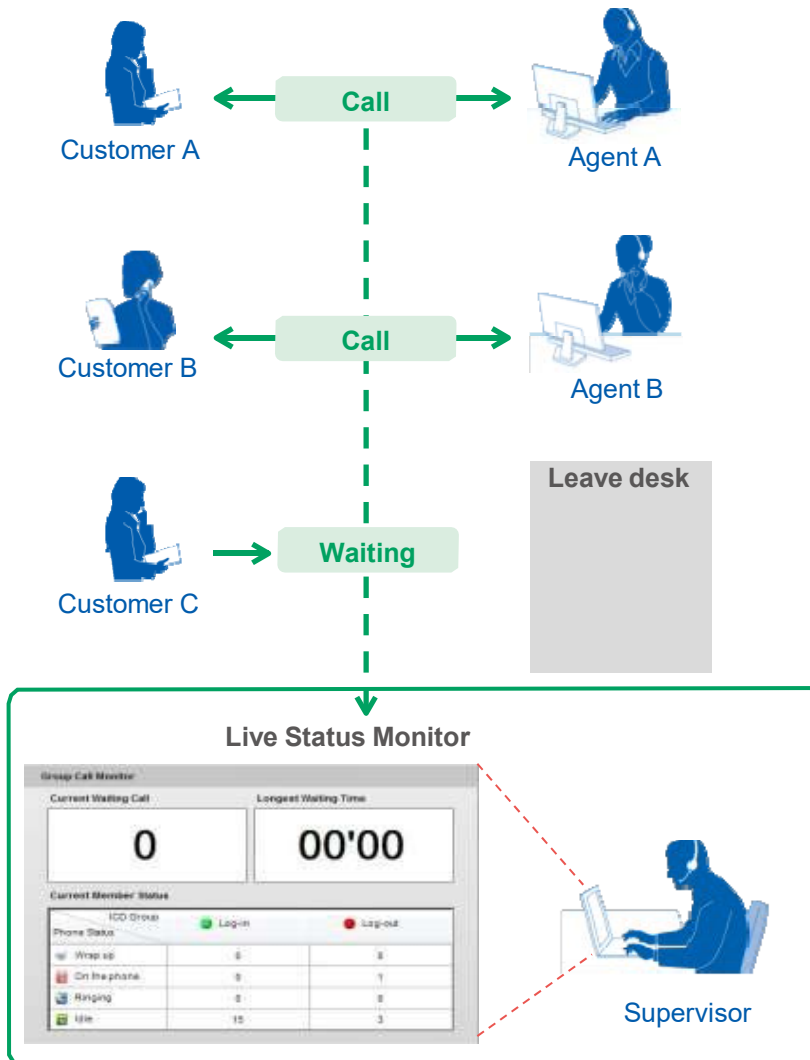

## Features and Benefits

▶ Since the call status can be monitored in real time, customer waiting times can be understood, and calls can be transferred to other agents or handled by the supervisor, etc., to reduce customer waiting time and stress.

## Recommended for:

- ▶ Companies that want to perform operations efficiently and in real time
- ▶ Companies that want to discover what problems they have

# Call Centre Solution -Activity Report-

The call centre supervisor is also provided a variety of reports for studying the activity of the KX-NS300.

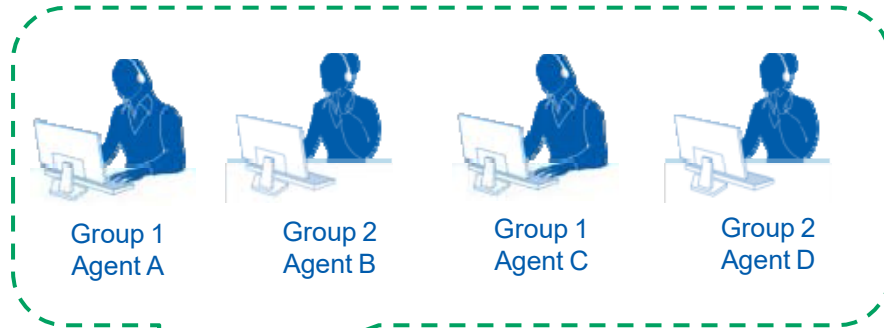

KX-NS500

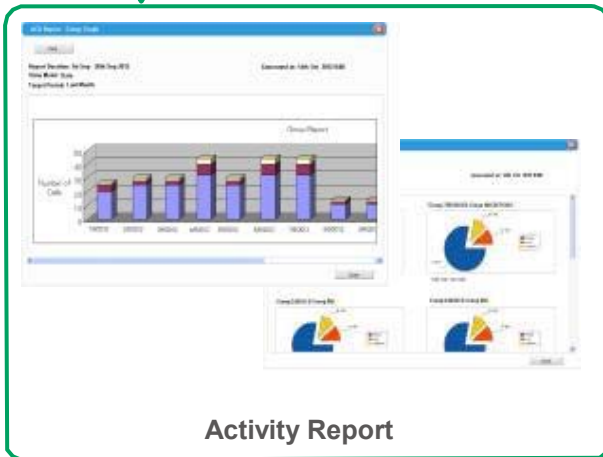

## Features and Benefits

- ▶ Reports can be made by agent and also by group.
- ▶ Since reports are provided in various formats, they can help analysis the call status.
- ▶ Call data for up to 300,000 calls can be stored.

## Recommended for:

- ▶ Companies that want to discover/analyze current problems
- ▶ Companies that want to perform continuous analysis to improve customer satisfaction

# Communication Assistant

Communication Assistant (CA) productivity software is a highly intuitive PC based application that enables you to change the contact method according to the status of the other party.

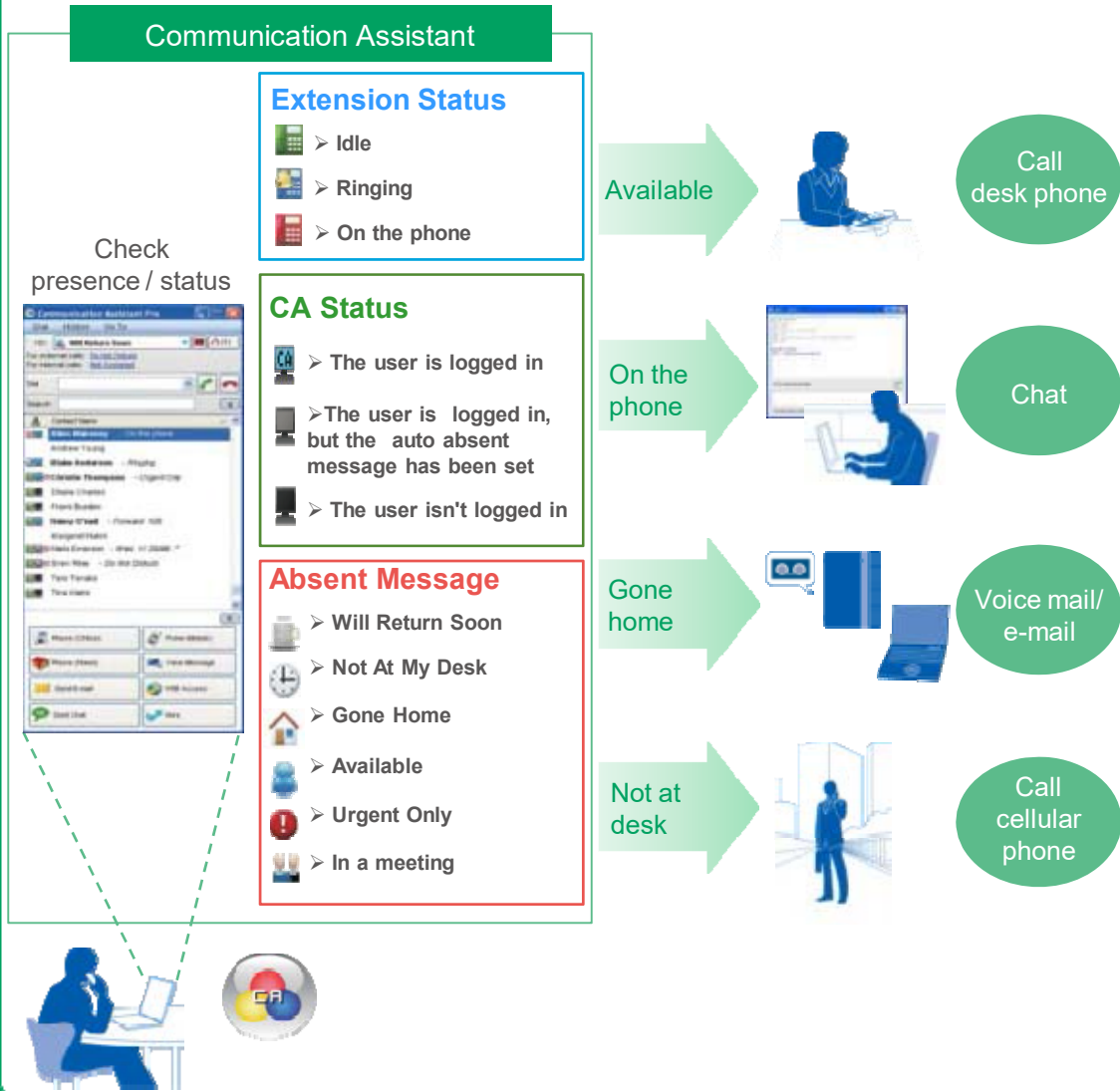

## Features and Benefits

- ▶ Enables the presence of co-workers to be checked to select the appropriate communication method
- ▶ Four editions (Basic/Pro/Console/Supervisor) available to meet various needs.
- ▶ Can be linked with various applications

## Recommended for:

- ▶ Employees often away from their desks
- ▶ Companies with relevant parties in different locations.
- ▶ Companies which have branches.

## Selling Points

# Simplified Maintenance -Web Maintenance-

The features described on previous pages can be programmed with a Web based console via an IP network. Phones and the VM mailbox can also be customised by users via the Web.

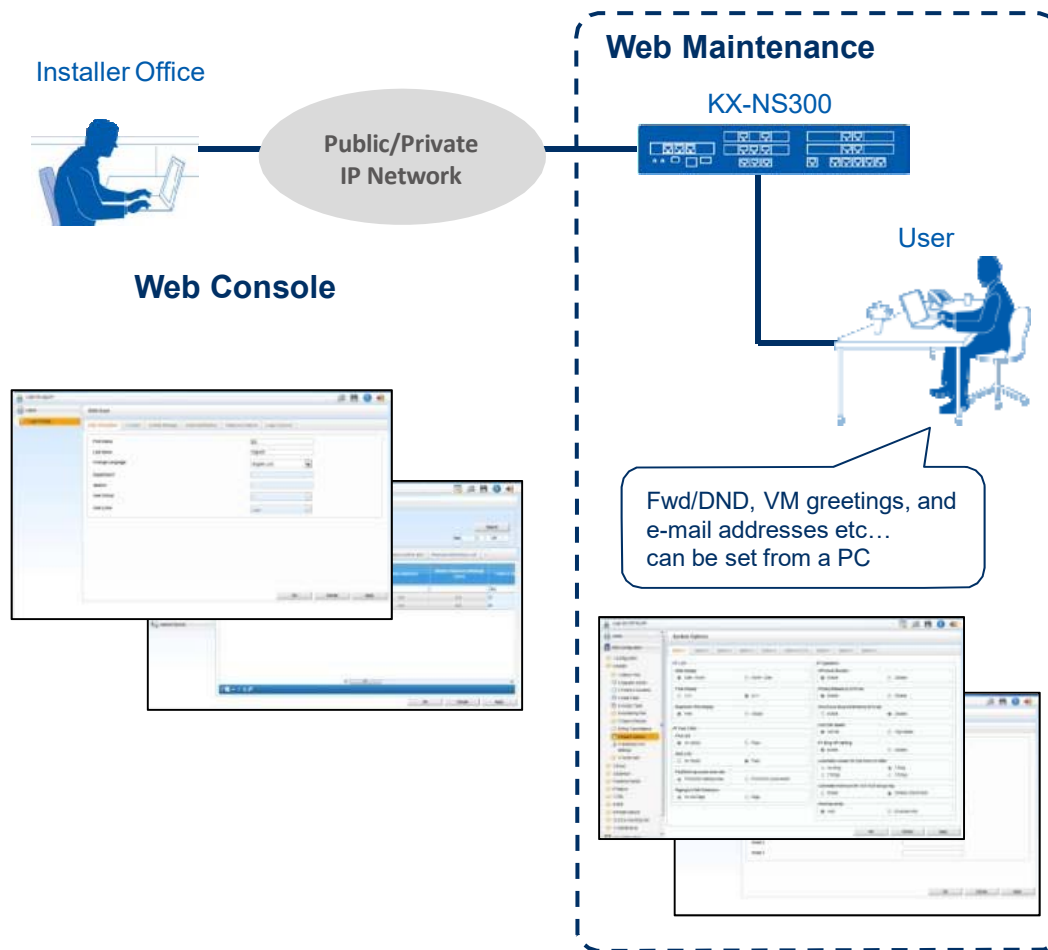

- Programming is easy for experienced Panasonic installers because the programming method is basically the same as the KX-TDA, KX-TDE, KX-NCP and KX-TVM.
- No need to install dedicated software on your PC.
- Use an IP network to perform programming from remote sites.
- A maximum of 1 installer can modify system data at the same time.
- A maximum of 32 users can access at the same time.

## KX-NS300 Capacity

### Maximum Trunks

		Preinstalled	KX-NS300	With 1 KX-NS320	With 2 KX-NS320	With 3 KX-NS320
Total Number of Trunks (Legacy+IP)		6 ch	100 ch	130 ch	160 ch	190 ch
Legacy		6 ch	36 ch	66 ch	96 ch	126 ch
	PRI30	N/A	30 ch	60 ch	90 ch	120 ch
	E1	N/A	30 ch	60 ch	90 ch	120 ch
	Analogue	6 lines	12 lines	24 lines	36 lines	48 lines
IP		N/A	64 ch	64 ch	64 ch	64 ch
	H.323	N/A	32 ch	32 ch	32 ch	32 ch
	SIP	N/A	64 ch	64 ch	64 ch	64 ch

# Hardware Condition

Item	Specification
Temperature	0 °C to 40 °C
Humidity	10 % to 90 % (non-condensing)
Power Input	100 V AC to 130 V AC: 2.2 A/200 V AC to 240 V AC: 1.3 A; 50 Hz/60 Hz
Power Consumption (when fully mounted)	110 W
External Backup Battery	External battery port is supported.
Memory Backup Duration	7 years
Air-cooling method	FAN
Dimension	430 mm (W) x 88 mm (H) x 367 mm (D)
Weight (when fully mounted)	Under 4.5 kg

## 19-inch Rack Mounting

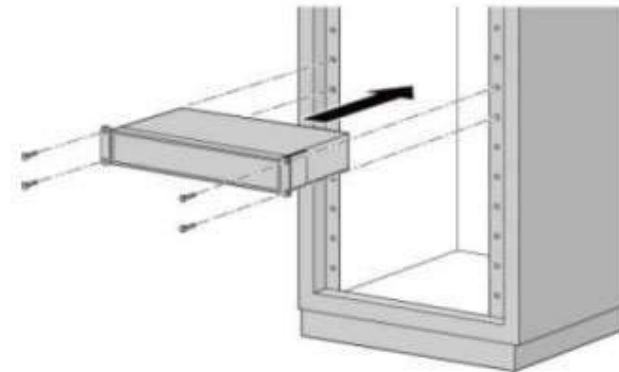

## Wall Mounting

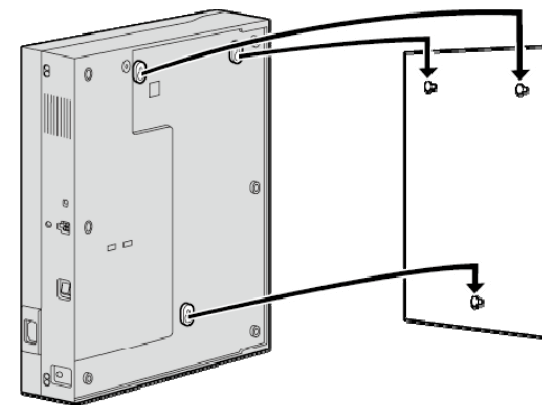



# Overview

Panasonic's full terminal line up from high end to low end provide various solutions to various types of businesses.

## Smart Hybrid PBX KX-NS300



### IP Proprietary Telephone

- Gigabit LAN/PC port
  - PoE
- Full duplex speakerphone
- Supports EHS for wireless headsets



### Digital Proprietary Telephone

- Full duplex speakerphone
- Supports EHS for wireless headsets



### Wireless Terminals

- Multifunctional design
- Seamless communication while you move from place to place during a call



# IP Phone 'KX-NT5xx Series'

## Lineup

### For Executives/Supervisors

#### KX-NT560

- 4.4 inch Backlight LCD Display
- 4 x 8 Self Labelling, Flexible CO Buttons
- 2 Giga Ethernet Ports (10/100/1000M)
- PoE
- Full Duplex Speakerphone
- Electronic Hook Switch
- Built-in Bluetooth Module
- Eco Mode



### For Simple Users

#### KX-NT511A/KX-NT511P

- 1-Line LCD Display
- 3 Flexible CO Buttons
- PoE (KX-NT511P only)
- 2 Ethernet Ports (10M/100M)
- AC Adaptor Included (KX-NT511A only)
- Full Duplex Speakerphone
- Eco Mode



A white model  
is available  
for each phone

### For Standard Users

#### KX-NT551

- 1-Line Backlight LCD Display
- 8 Flexible CO Buttons
- 2 Ethernet Ports (10/100/1000M)
- Full Duplex Speakerphone
- PoE
- Eco Mode



#### KX-NT556/KX-NT553 with KX-NT505

- 6-Line Backlight LCD Display  
(KX-NT553: 3-Line)
- 12 x 3 Self Labelling, Flexible CO Buttons  
(KX-NT553: 12 x 2)
- 2 Ethernet Ports (10/100/1000M)
- PoE
- Full Duplex Speakerphone
- Electronic Hook Switch
- Eco Mode
- Options: KX-NT505 (Add on 48 key module)



#### KX-NT546/KX-NT543

- 6-Line Backlight LCD Display  
(KX-NT543: 3-Line)
- 24 Flexible CO Buttons
- 2 Ethernet Ports (10/100M)
- PoE
- Speakerphone
- Electronic Hook Switch
- Eco Mode



# IP Phone 'KX-NT5xx Series'

## Features

### High Audio Quality

➤ **Full duplex speakerphone (KX-NT560/KX-NT55x Series/KX-NT511)**

The speakerphone supports "full duplex", enabling both parties to speak at the same time without their voice getting cut out.

➤ **Supports the G.722 codec**

G.722 codec provides calls with high quality and reduced stress.

➤ **Advanced speaker design**

Speakers enhance the characteristics of low frequencies and contain a high performance D-class audio amp.

➤ **Larger acoustic chamber**

The acoustic chamber reduces echo and vibration from the speaker.

### Hands Free Communication

➤ **Built-in Bluetooth (KX-NT560 only)**

Bluetooth for wireless calls using a supported headset.

➤ **Electronic Hook Switch (EHS) supported (Except for KX-NT551/KX-NT511)**

By connecting an EHS headset, you can perform wireless communication.



# IP Phone 'KX-NT5xx Series'

## High Speed Communication

- **Supports Gigabit Ethernet (KX-NT560/KX-NT55x Series)**  
Enables high-speed data transfer.



## Easy to Use Design

- **Paper label free (KX-NT560/KX-NT556/KX-NT553)**  
Since the numbers are displayed on the screen, a paper label is not required.



Paper label free

- **Small footprint reduces desk space**
- **Longer handset curly cord**







Small footprint



Longer handset curly cord

# IP Phone 'KX-NT5xx Series'



## Specifications

Model Number		KX-NT551	KX-NT553	KX-NT556	KX-NT560
					
<b>Functions</b>	<b>LCD</b>	1-Line, Monochrome	3-Line, Monochrome	6-Line, Monochrome	6-Line, Monochrome
	<b>Backlight</b>	Yes			
	<b>Speakerphone</b>	Yes (Full Duplex)			
	<b>FF Button</b>	8	2 x 12 (Self Labelling)	3 x 12 (Self Labelling)	4 x 8 (Self Labelling)
	<b>Bluetooth Headset Connectability</b>	N/A			Built-in
	<b>Electronic Hook Switch</b>	N/A	Yes*1		
	<b>Ethernet Port</b>	2 ports (10/100/1000M)			
	<b>POE</b>	Yes (802.3af compliant)			
	<b>Others</b>	IPv4, DHCP Client, Audio Codec (G.722/G.711/G.729a), Echo Cancellation, Microphone			
<b>Options</b>	<b>AC Adaptor</b>	KX-A239			
	<b>Wall Mount Kit</b>	KX-A432	KX-A433		
	<b>Wired Headset</b>	RP-TCA400/430			
<b>Others</b>	<b>Colour Variation</b>	White, Black			

\*1: Only a Φ3.5mm pin jack is connectable.  
 Note: Some operations may vary depending on the type of telephone being used.

# IP Phone 'KX-NT5xx Series'

### Specifications

Model Number		KX-NT511A	KX-NT511P	KX-NT543	KX-NT546
					
<b>Functions</b>	<b>LCD</b>	1-Line, Monochrome		3-Line, Monochrome	6-Line, Monochrome
	<b>Backlight</b>	N/A		Yes	
	<b>Speakerphone</b>	Yes (Full Duplex)		Yes	
	<b>FF Button</b>	3		24	
	<b>Bluetooth Headset Connectability</b>	N/A			
	<b>Electronic Hook Switch</b>	N/A		Yes*1	
	<b>Ethernet Port</b>	2 ports (10/100M)			
	<b>PoE</b>	N/A	Yes	Yes (802.3af compliant)	
	<b>Others</b>	IPv4, DHCP Client, Audio Codec (G.722/G.711/G.729a), Echo Cancellation, Microphone			
<b>Options</b>	<b>AC Adaptor</b>	Attached	N/A*2	KX-A239	
	<b>Wall Mount Kit</b>	Built-in		KX-A433	
	<b>Wired Headset</b>	N/A		RP-TCA400/430	
<b>Others</b>	<b>Colour Variation</b>	White, Black			

\*1: Only a Φ3.5mm pin jack is connectable.

\*2: Service parts

Note: Some operations may vary depending on the type of telephone being used.

# Digital Phone 'KX-DT5xx Series'

## Lineup

### For Executives/Supervisors

#### KX-DT546 with KX-DT590

- 6-Line Backlight LCD Display
- 24 Flexible CO Buttons
- Full Duplex Speakerphone
- Electronic Hook Switch
- Options

KX-DT590: Digital DSS console (48-Key)



### For Standard Users

#### KX-DT543

- 3-Line Backlight LCD Display
- 24 Flexible CO Buttons
- Full Duplex Speakerphone
- Electronic Hook Switch
- Options

KX-DT590: Digital DSS console (48-Key)



### For Simple Users

#### KX-DT521

- 1-Line Backlight LCD Display
- 8 Flexible CO Buttons
- Full Duplex Speakerphone
- Options

KX-DT590: Digital DSS console (48-Key)



A white model  
is available  
for each phone

# Digital Phone 'KX-DT5xx Series'

## Features

### High Audio Quality

➤ **Full duplex speakerphone**

The speakerphone supports “full duplex”, enabling both parties to speak at the same time without their voice getting cut out.

➤ **Advanced speaker design**

Speakers enhance the characteristics of low frequencies and contain a high performance D-class audio amp.

➤ **Larger acoustic chamber**

The acoustic chamber reduces echo and vibration from the speaker.



### Hands Free Communication

➤ **Electronic Hook Switch (EHS) supported (KX-DT546/KX-DT543)**

By connecting an EHS headset, you can perform wireless communication.

### Easy to Use Design

➤ **Small footprint reduces desk space**

➤ **Longer handset curly cord**

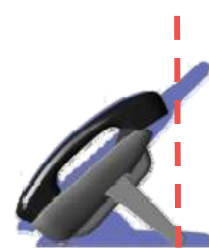

Small footprint





Longer handset curly cord



# Digital Phone 'KX-DT5xx Series'

## Specifications

Model Number		KX-DT521	KX-DT543	KX-DT546
				
Functions	LCD	1-Line, Monochrome	3-Line, Monochrome	6-Line, Monochrome
	Backlight	Yes		
	Speakerphone	Yes (Full Duplex)		
	FF Button	8	24	
	Bluetooth Headset Connectability	N/A		
	Electronic Hook Switch	N/A	Yes*1	
	Ethernet Port	N/A		
	PoE	N/A		
	Others	Audio Codec (G.711), Echo Cancellation, Microphone, 1 DXDP Port		
Options	AC Adaptor	N/A		
	Wall Mount Kit	KX-A432	KX-A433	
	Wired Headset	KX-TCA400/430, RP-TCA400/430		
Others	Colour Variation	White, Black		

\*1: Only a Φ3.5mm pin jack is connectable.

Note: Some operations may vary depending on the type of telephone being used.

# Wireless Terminal

## Lineup

### Standard Model

**KX-TCA185**



### Slim & Light Model

**KX-TCA285**



**KX-TCA385**



- Noise Reduction
- Built-in Bluetooth Headset interface (KX-TCA285/KX-TCA385)
- DECT Paging
- DECT for CTI
- Wireless XDP Parallel Function



\*IP65 compliant: Protection against dust entering the handset, and protection against water spraying from any direction.

# Wireless Terminal

## Features

### Noise Countermeasures

#### ➤ Noise reduction

Detect and reduce the noise parts of transmitted voices

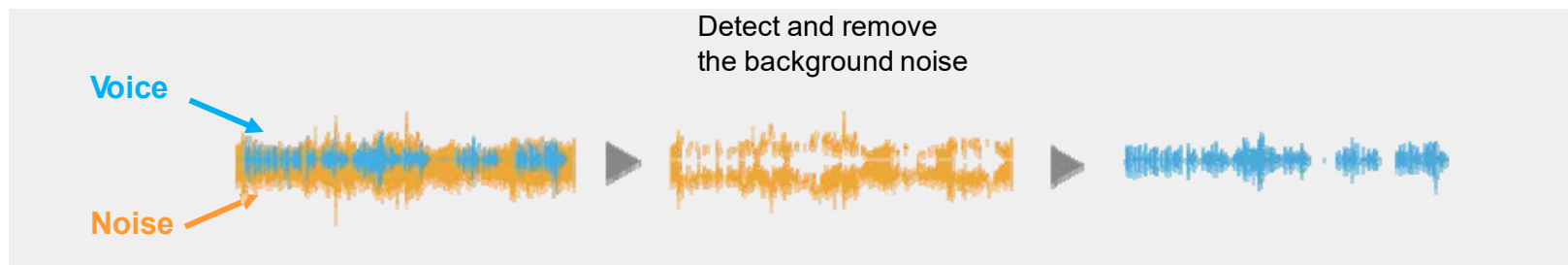

#### ➤ Dynamic listening volume control

When the KX-TCA series detects noise, it automatically increases the receiver volume to an easy-to-hear level.



### Hands Free Communication



#### ➤ Built-in Bluetooth (KX-TCA285/KX-TCA385)

Bluetooth for wireless calls using a supported headset.



# Wireless Terminal

## Specifications



	Standard Model KX-TCA185	Slim & Light Model KX-TCA285	IP65 Tough Type Model KX-TCA385
<b>Model Number</b>			
<b>LCD</b>		1.8 inch TFT Colour	
<b>PBX Linked Feature*1</b>	Yes		
<b>Speakerphone</b>	Yes (Full Duplex)		
<b>PBX Flexible CO Button</b>	12		
<b>Soft Keys</b>	3		
<b>Headset Jack</b>	Yes*2		N/A
<b>Noise Reduction</b>	Yes		
<b>Wireless XDP Parallel Function</b>	Yes		
<b>Conference Function</b>	Yes		
<b>DECT Paging</b>	Yes		
<b>PS Ring Group</b>	Yes		
<b>Vibration</b>	Yes		
<b>Splash and Dust Resistant</b>	N/A		IP65
<b>DECT Encryption</b>	Ready		

\*1 Examples: PBX Call Log/PBX System Phonebook/PBX Personal Programming etc.

\*2 Only a  $\Phi 2.5$ mm pin jack is connectable.



# Wireless Terminal

## Specifications

IP Cell Station KX-NCP0158	Cell Station KX-TDA0158
	
<ul style="list-style-type: none"> <li>● Wireless solution for remote office communication</li> <li>● Provides 8 call user connections over 10/100Mbit LAN</li> <li>● No special cabling required (overcomes distance issues)</li> <li>● Air synchronization technology</li> <li>● Powered by both PoE and AC adaptor (sold separately)</li> <li>● No activation key requirements</li> <li>● DHCP client/static address</li> </ul>	<ul style="list-style-type: none"> <li>● Solution to the office with dense population of user customer</li> <li>● Up to 8 simultaneous calls</li> <li>● DTP-IF (4 DPT port)</li> <li>● Powered by PBX</li> <li>● No activation key requirements</li> </ul>

# Wireless Terminal

## Specifications

Cell Station KX-TDA0155	Repeater KX-A405
	
<ul style="list-style-type: none"> <li>● Up to 2 simultaneous calls</li> <li>● DTP-IF</li> <li>● Powered by PBX</li> <li>● No activation key requirements</li> </ul>	<ul style="list-style-type: none"> <li>● Designed to extend the range of a DECT Portable station</li> <li>● Up to 6 repeaters can be registered to one cell station*</li> <li>● Up to 3 repeaters can be registered in a cascade configuration</li> <li>● Powered by AC adaptor</li> <li>● Wall mountable</li> </ul>

\* With the KX-NCP0158/KX-TDA0158/KX-TDA0155

# Call Centre Solution - "CC View" Activity Monitor and Report Tool

"CC View" provides a more detailed activity monitor and reports than the built-in function (page 41-42).

Monitoring screen sample

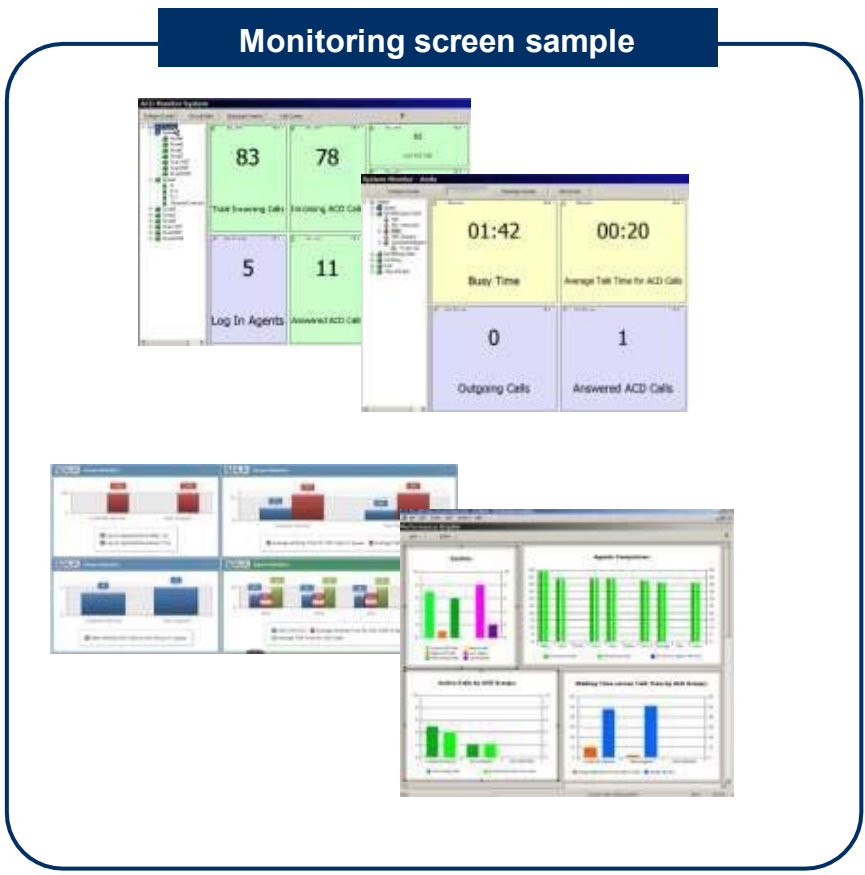

Report sample

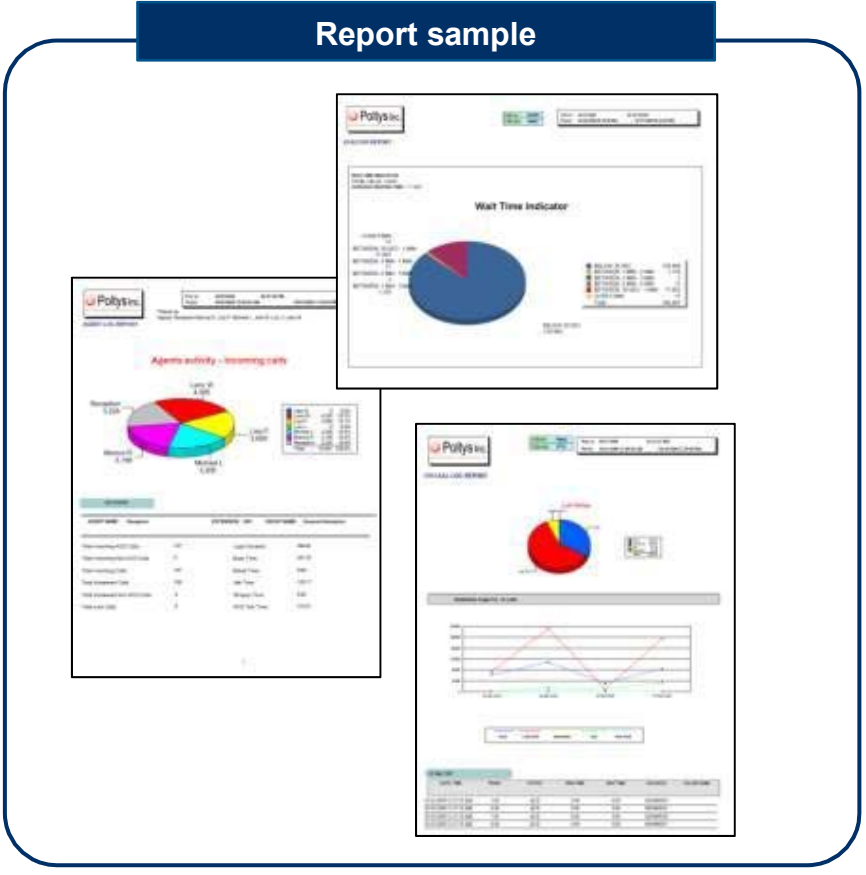

# Communication Assistant

## Lineup

For details, see page 48, 56, 73-92.

### CA Basic-Express, CA PRO

- For Personal Productivity,
- For General Offices

Intuitive point and click telephony fully featured with real-time presence indication  
Stay informed of users availability in different locations.



CA Basic-Express Free

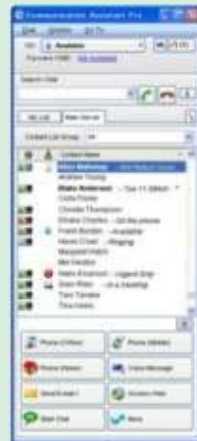

CA PRO

### CA Operator Console

- For Operators / Agents
- For Reception / Secretaries

An agent can use the software to easily handle calls, and professionally handle communication between customers and colleagues.



### CA Supervisor

- For Team / Group Productivity
- For Call Centres

A team supervisor can easily monitor and manage the real-time telephony activities of group members and agents.





# Communication Assistant

## Presence

Users can save time and enjoy smoother communication by checking the status of co-workers on a PC screen right at their desk. Users can also choose the most suitable communication method to make calls, send e-mails, or chat with others, depending on the situation.

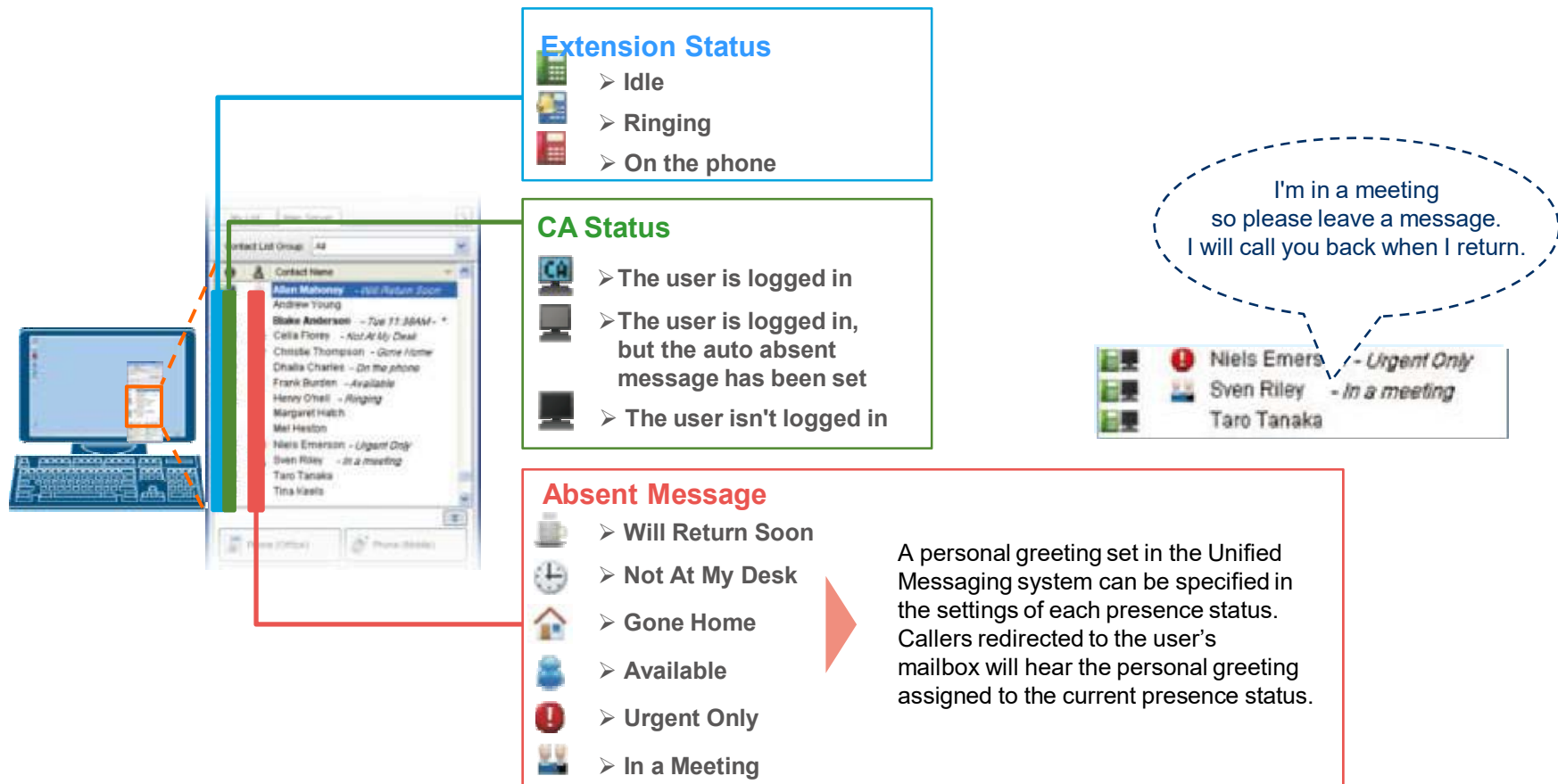

# Communication Assistant Communication Assistant

## Conference Feature

Using the conference function, you can create ten conference groups of up to 32 people, simply by dragging and dropping members from the contact list. Conference groups can be entered with a group name of your choice. Only three clicks are required to start a conference.

### Editing conference group settings

To add members to a conference, drag and drop contacts from the contact list to the conference setting window, or right-click a contact and select Add Member To Conference.

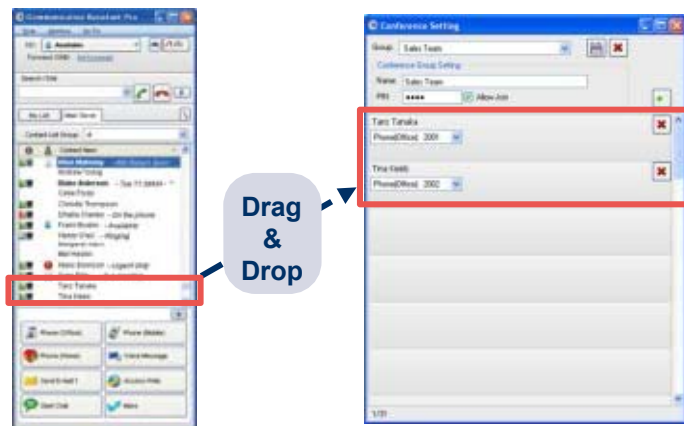

### Conference room window

During a conference, the originator of the conference can enable or disable the ability of other members to speak, put them on hold, or remove them from the conference.

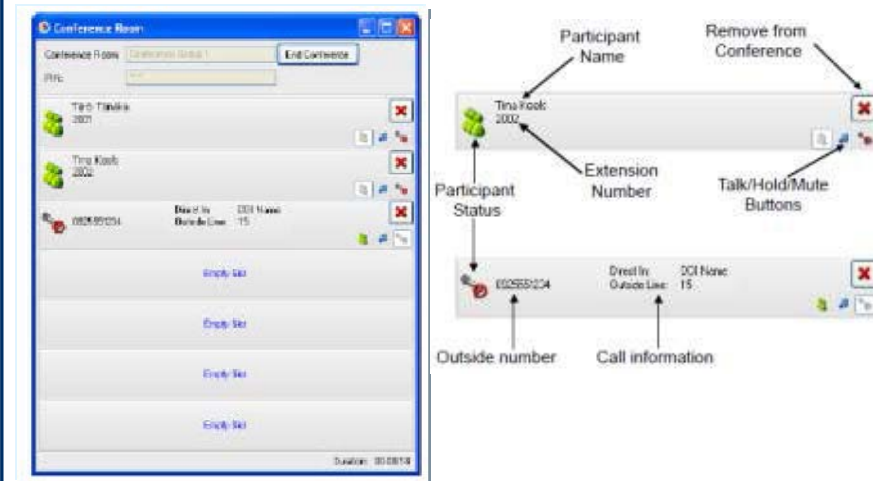

# Communication Assistant

## Microsoft Outlook Integration

CA can seamlessly integrate with Microsoft Outlook® 2003/2007/2010. During the installation of CA Client, if you select to add call functions to Outlook, a toolbar will be added to Outlook. The toolbar offers many of the call features of CA Client.

### Pop-up Outlook Contact Window for Incoming Calls



When a call is incoming, the Outlook contact information of that caller will appear.

### Outlook Tool Bar

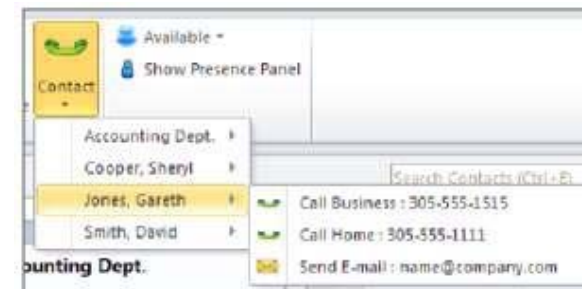
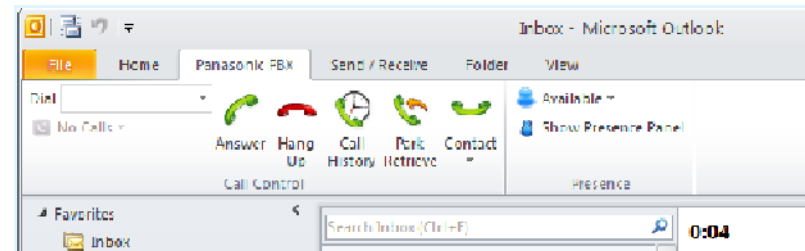

# Communication Assistant

## Microsoft Exchange Server Integration

If a CA server is installed on your network, you can integrate a Microsoft Exchange calendar with CA Client. When this is done, your presence will automatically change according to the content of your Exchange calendar (by referring to a matching table). You can also set keywords in your calendar's schedule to change your presence.

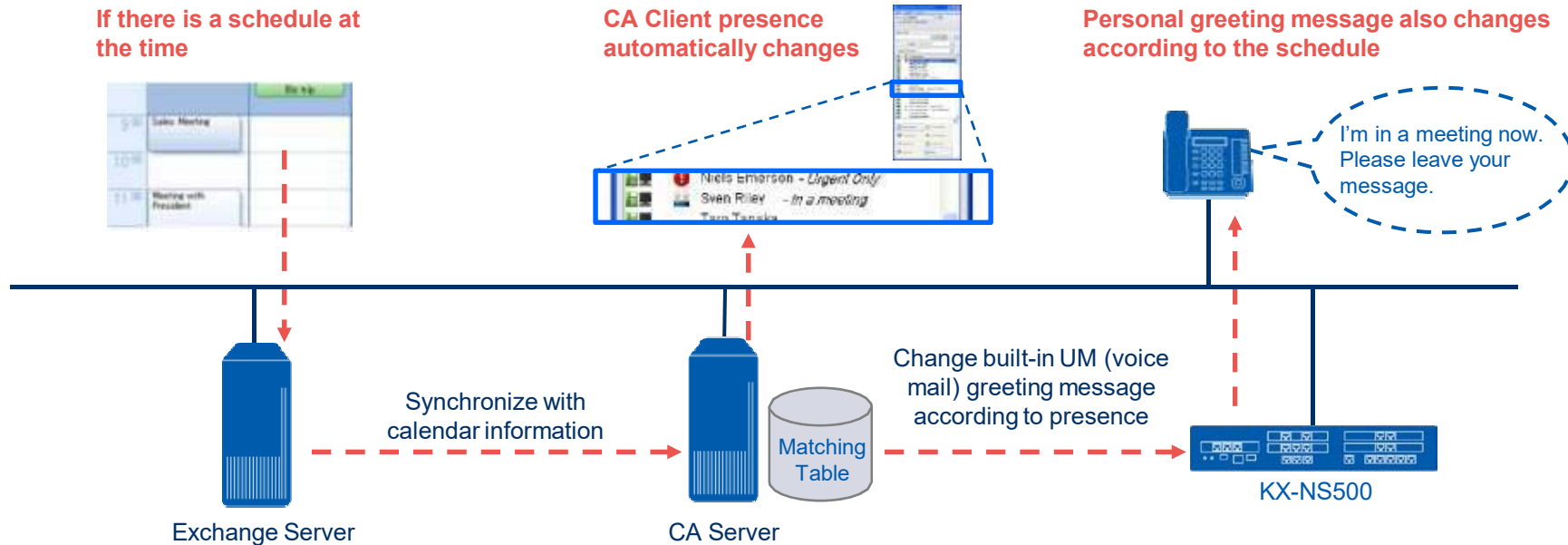

<Note>  
The supported versions of Exchange Server are 2007 and 2010. 2003 is not supported.

## Communication Assistant

### CRM Integration (TAPI/CSTA Support)

CRM integration enables linking with a wide range of CRM software by installing middleware.

CA Client also has a 1<sup>st</sup> party TAPI, which is a standard interface.

Functions that can be linked with CRM software include call pop-ups using caller ID, the CRM phone book, and calling from applications.

For information about middleware and supported CRM software types, contact your Panasonic sales company.

# Communication Assistant

## Thin Client Environment Support

CA Client can be used in a thin client environment. The supported thin client environments are Citrix XenApp™ and Microsoft Terminal Service. A CA server and a thin client activation key (KX-NSA010) are required to enable thin client support. Since personal information such as address books is not retained on the client PCs, safety is enhanced from an information security perspective.

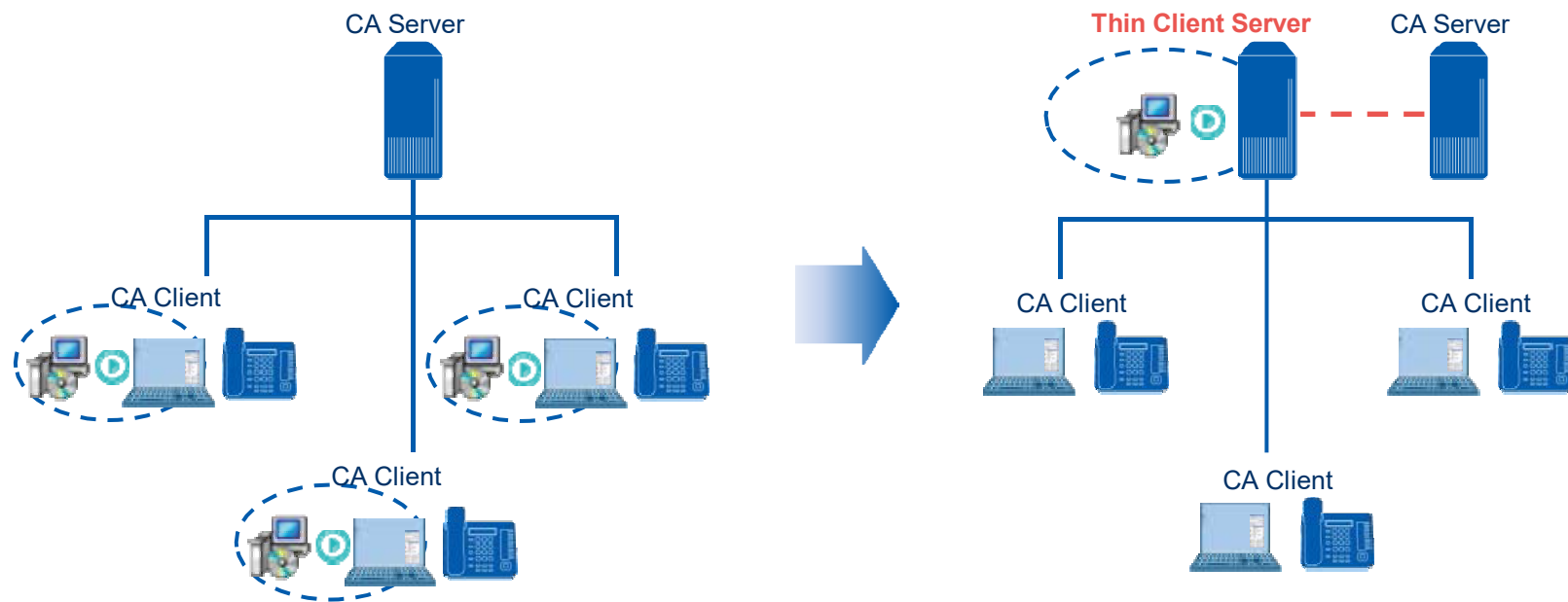

<NOTE>

When using CA Client in a thin client environment, the following features are not available:  
IP Softphone, 1st Party TSP features, 3rd Party CRM Integration, Microsoft Outlook Integration

# Communication Assistant

## Network Camera Integration

Panasonic network cameras can integrate with a CA desktop PC. This allow users to view video on their PC from a remote location simply by clicking the access web in the CA contact list. By linking a registered door phone, users can also answer calls and open the door after confirming video on the screen.



<NOTE>  
Browser for viewing: Internet Explorer® 6.0 or later

# Communication Assistant

## Follow me function (CA integration with public telephone numbers)

CA can work with mobile phones or home phones. Home workers can make calls using the KX-NS500, to reduce telephone charges. Outgoing and internal calls can be made by using CA when outside.

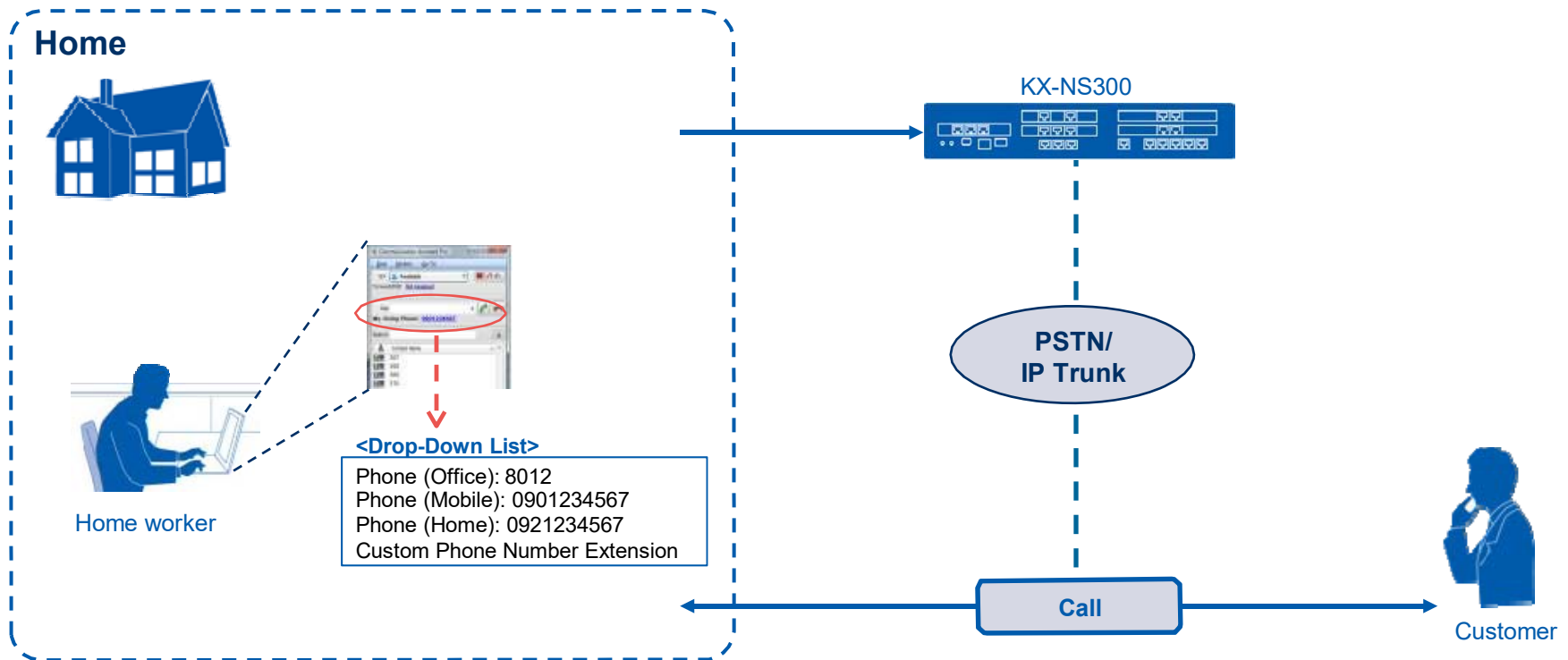



# Communication Assistant

## CA Operator Console - Overview

CA Operator Console

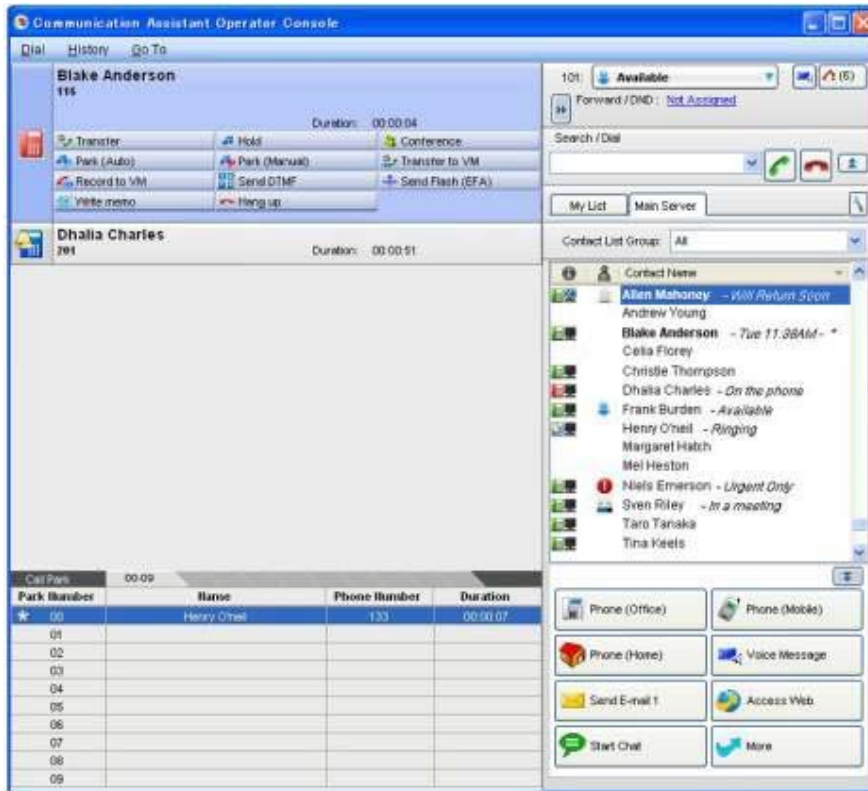

For  
- Agents  
- Receptionists

### Easy Call Handling

Users can manage multiple calls simultaneously using a graphic interface.

### Extension Setting

Various extension settings can be set.

- Set a wake-up call
- Set and clear the absent message, etc.



# Communication Assistant

## CA Operator Console - Easy Call Handling

The status of received and parked calls are displayed in the Arriving Calls Screen, allowing a single agent to handle multiple controls. Agents can easily transfer and park calls with a simple drag & drop operation.

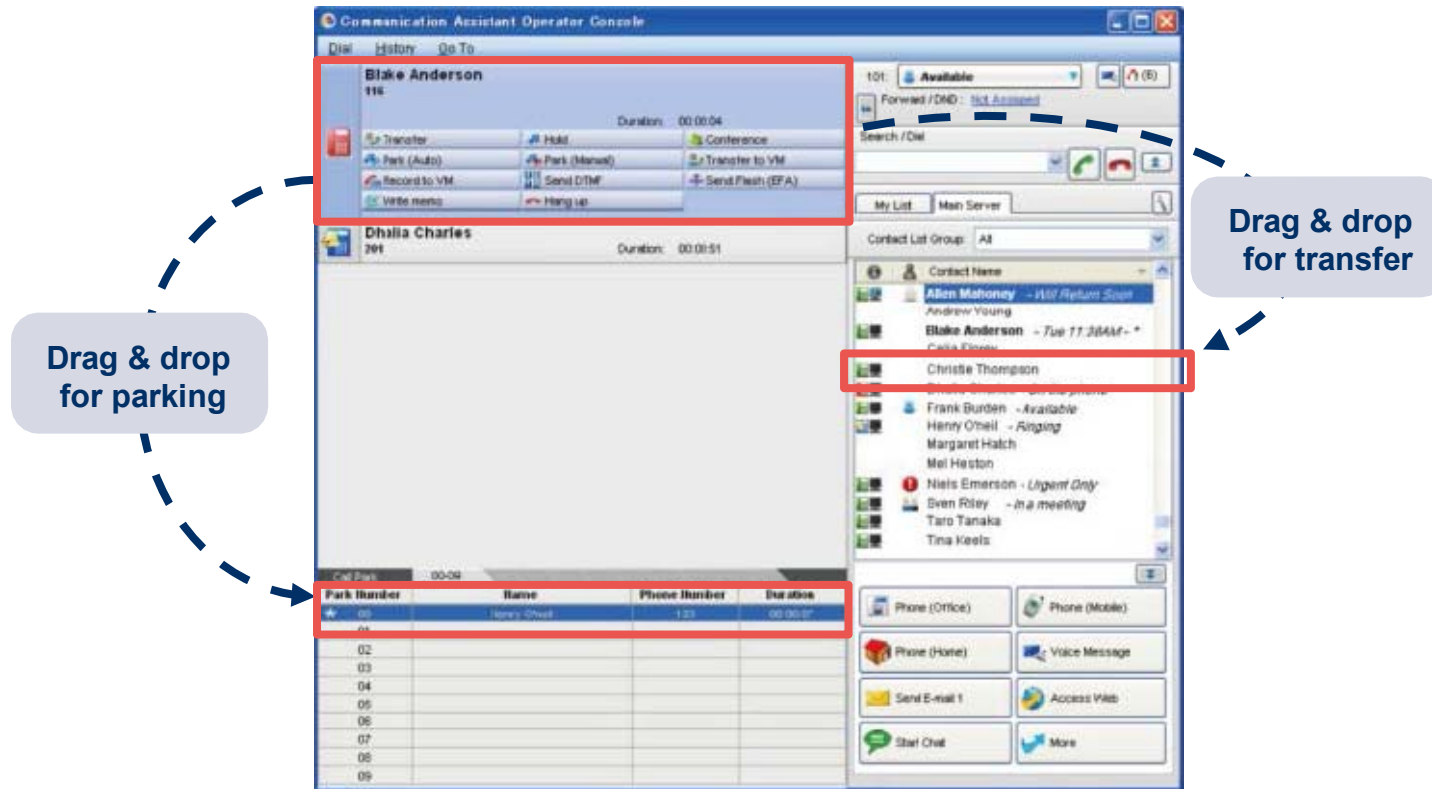

# Communication Assistant

## CA Operator Console - Extension Settings

Operators can set and change the settings of each extension.

Operators can set the following

- FWD/DND
- Clear the extension PIN
- Set a wake up call
- Set/clear absent message
- Extension lock/unlock

### For the Hospitality Industry



### Example: Set a wake up call

The 'Extension Setting' window displays a table with the following data:

Number	Name	FWD/DND (Internal)	FWD/DND (External)	Display Lock	Dial Lock	Wake Up
101	101	Not Assigned	Not Assigned			
102	102	Not Assigned	Not Assigned			
103	103	Not Assigned	Not Assigned			
104	104	Not Assigned	Not Assigned			
105	105	Not Assigned	Not Assigned			
106	106	Not Assigned	Not Assigned			
107	107	Not Assigned	Not Assigned			

The 'Wake Up Call Setting' dialog box shows:

- Wake Up Call
- 7 h 0 min
- Daily Setting:  Once  Daily
- OK Cancel

The final screenshot shows the 'Wake Up' button in the extension settings table circled in red, with a value of '07h 00min Daily' below it.

# Communication Assistant

## CA Supervisor - Overview

### CA Supervisor

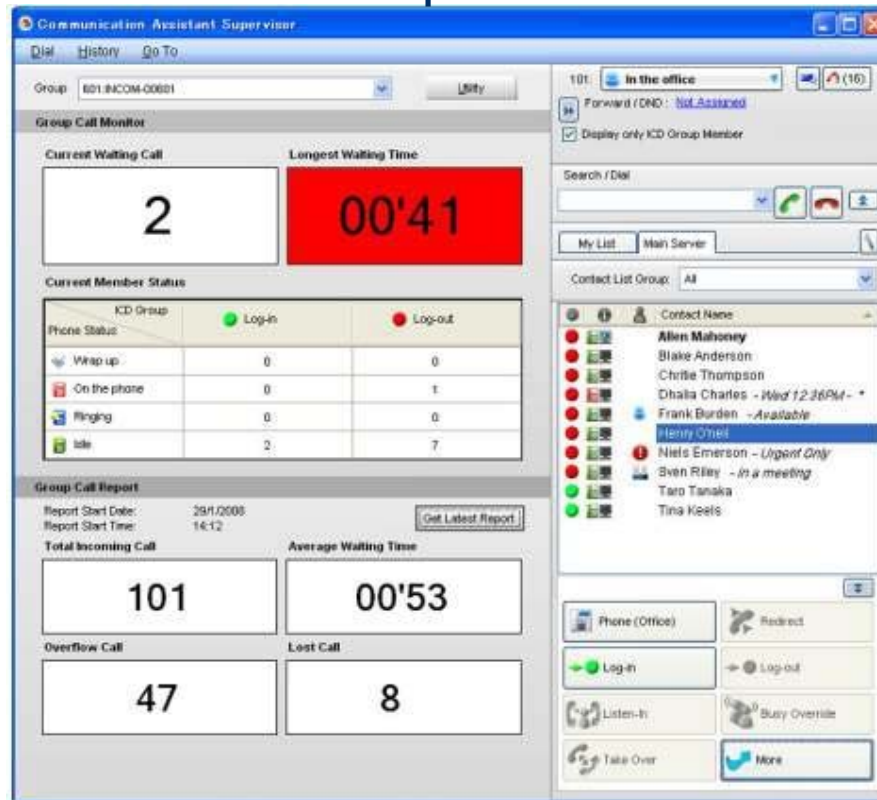

For  
- Supervisors  
- Managers

### Real-time Status Management

Supervise customer call handling by monitoring in real-time the number of calls waiting and the longest wait time.

Monitor agent status and control login and logout operations.

Manage the performance of all agents in a group.

### Agent Support

Support agents who need help with difficult customer calls. (Listen-in, Busy Override, etc.)

# Communication Assistant

## CA Supervisor - Real-time Status Management

Supervisors can monitor the status of a target group's agents with the Group Call Monitor feature.

**Current Waiting Call**: 2

**Longest Waiting Time**: 00'41

Phone Status	Log-in	Log-out
Wrap up	0	0
On the phone	0	1
Ringing	0	0
Idle	2	7

**Total Incoming Calls**: 101

**Average Waiting Time**: 00'53

**Overflow Calls**: 47

**Lost Calls**: 8

**Agent List:** Allen Maloney, Blake Anderson, Chris Thompson, Drake Charles - Ring 12:25PM, Frank Burden - Available, Niss Emerson - Agent Only, Ben Riley - In a meeting, Taro Tanaka, Tia Kiehl

# Communication Assistant

## CA Supervisor - Agent Support

Supervisors can support agents who need help with difficult customer calls.

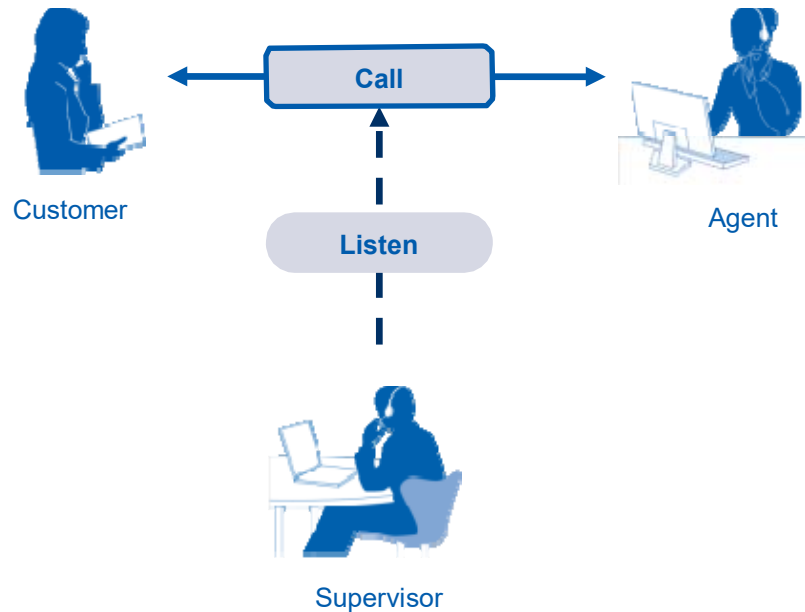

### ➤ Listen-In

Supervisors can listen in to the conversation of any agent extension number.

### ➤ Take Over

Supervisors can take over the telephone conversations of agent extension numbers.

### ➤ Busy Override

Supervisors can override the call of any agent extension number.

# Communication Assistant -CA Modules as CA Family-

## CA Modules as CA Family



Click!

CA Modules screen



Select an application

- 1. Conference Bridge
- 2. Appointment Reminder
- 3. Speech Auto Attendant
- 4. Outbound Dialer
- 5. ACD Reports

# Communication Assistant -CA Modules as CA Family-

## Conference Bridge Module

The CA Conference Bridge module provides a conference room for multi-party audio conferences. The conference schedule and participants can be set or maintained by the supervisor.

### Meet-me conference



- Scheduled Meet-Me conference
- Automatic scheduled dial-out conference
- Maximum 50 conference rooms
- Maximum 96 participants per room
- Total of 100 simultaneous attendees per system



# Communication Assistant -CA Modules as CA Family-

## Appointment Reminder Module

The CAAppointment Reminder module places outbound calls to deliver specific appointment reminder information to each called recipient at a pre-defined date and time. It is useful for preventing customer no shows.

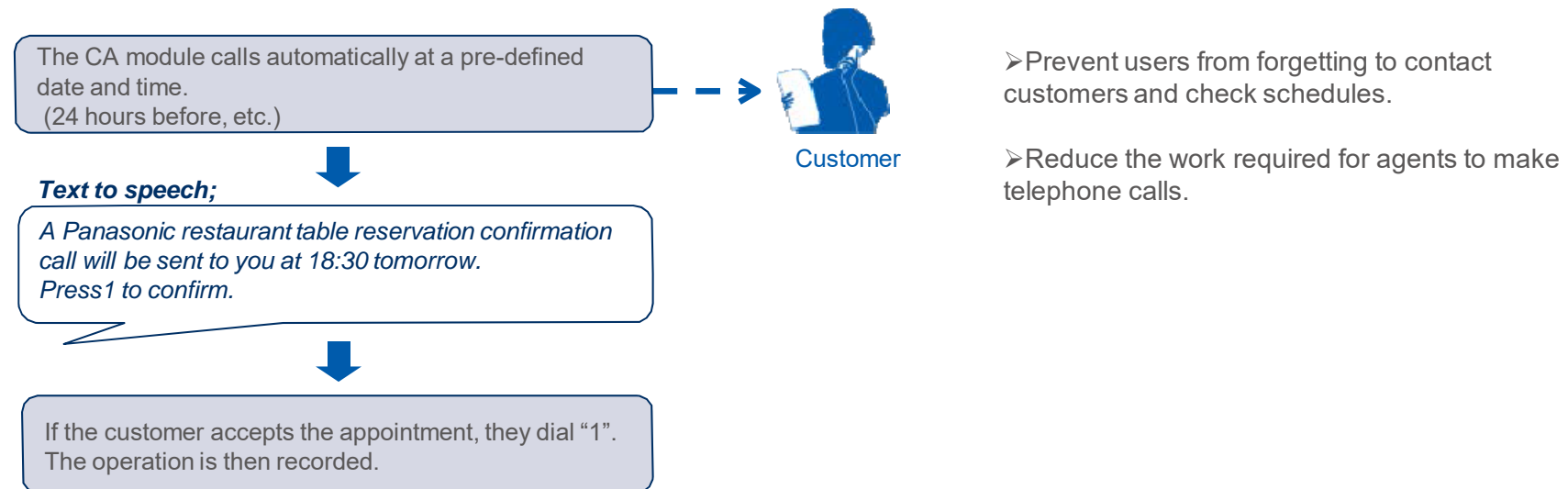

# Communication Assistant -CA Modules as CA Family-

## Speech Auto Attendant Module

The CA Speech Auto Attendant module provides a call routing function. Calls are redirected to voicemail or a mobile phone, etc. according to the CA status after the caller tells the module the name of the caller they want to talk to.

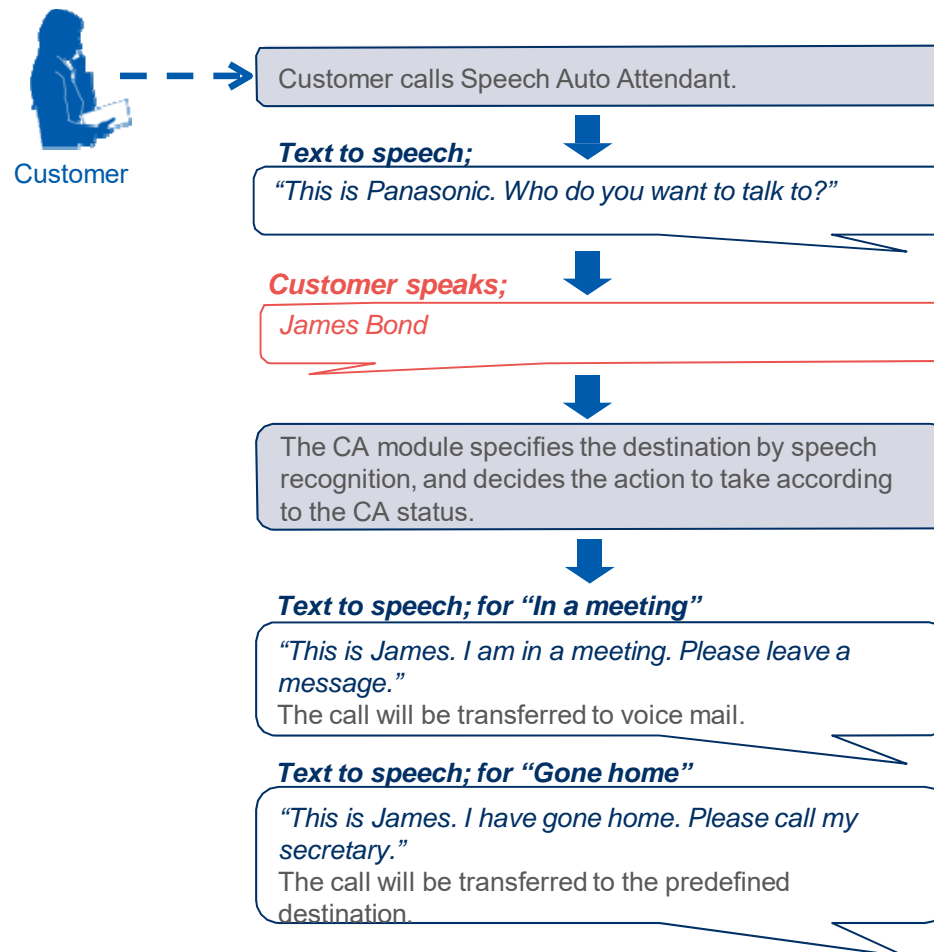

➤ Customers can connect to people in charge without pressing buttons

➤ When the agent a customer wants to talk to is absent, the customer can leave voice mail or a message for another person in charge

➤ By simply changing the CA status, communication can be performed with a method according to that status

# Communication Assistant -CA Modules as CA Family-

## Outbound Dialer Module

The CA Outbound Dialer module is a productivity tool that automatically places calls to a predefined list of phone numbers when the agent is idle.

It is useful for reducing misdialing and the time it takes to enter phone numbers.

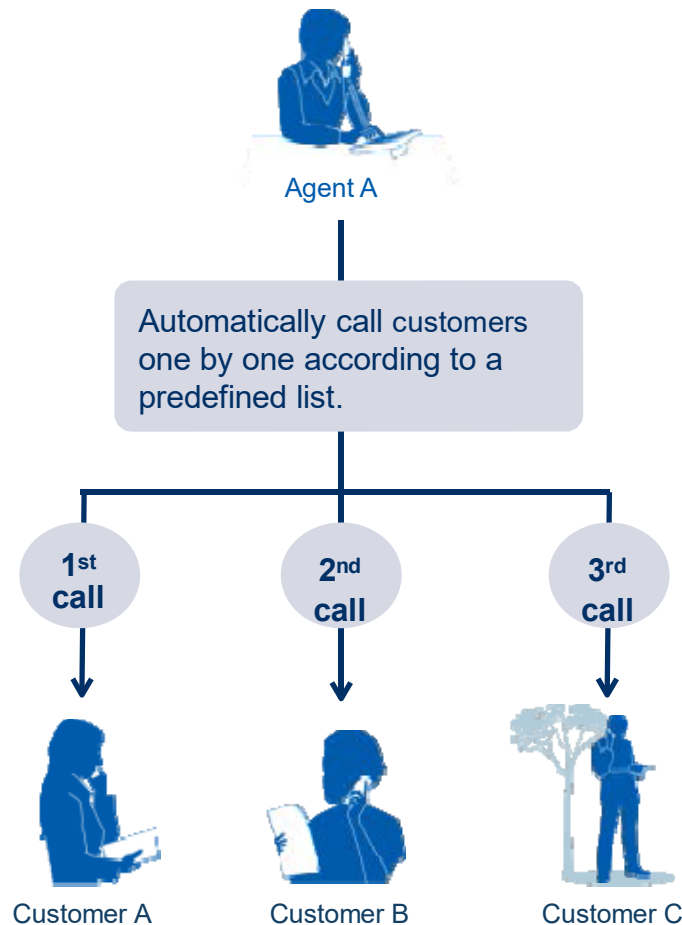

➤ Reduce call mistakes made by agents and the time it takes to dial.

➤ Reduce the time that agents are free to improve work efficiency.

# Communication Assistant -CA Modules as CA Family-

## ACD Reports Module

The CAACD Reports module is a productivity tool that provides Call Centre reporting features, adding ACD Call Centre specific functionality to CA.

By adding the CA module to CA Supervisor, monitoring and reporting can be provided on one PC.

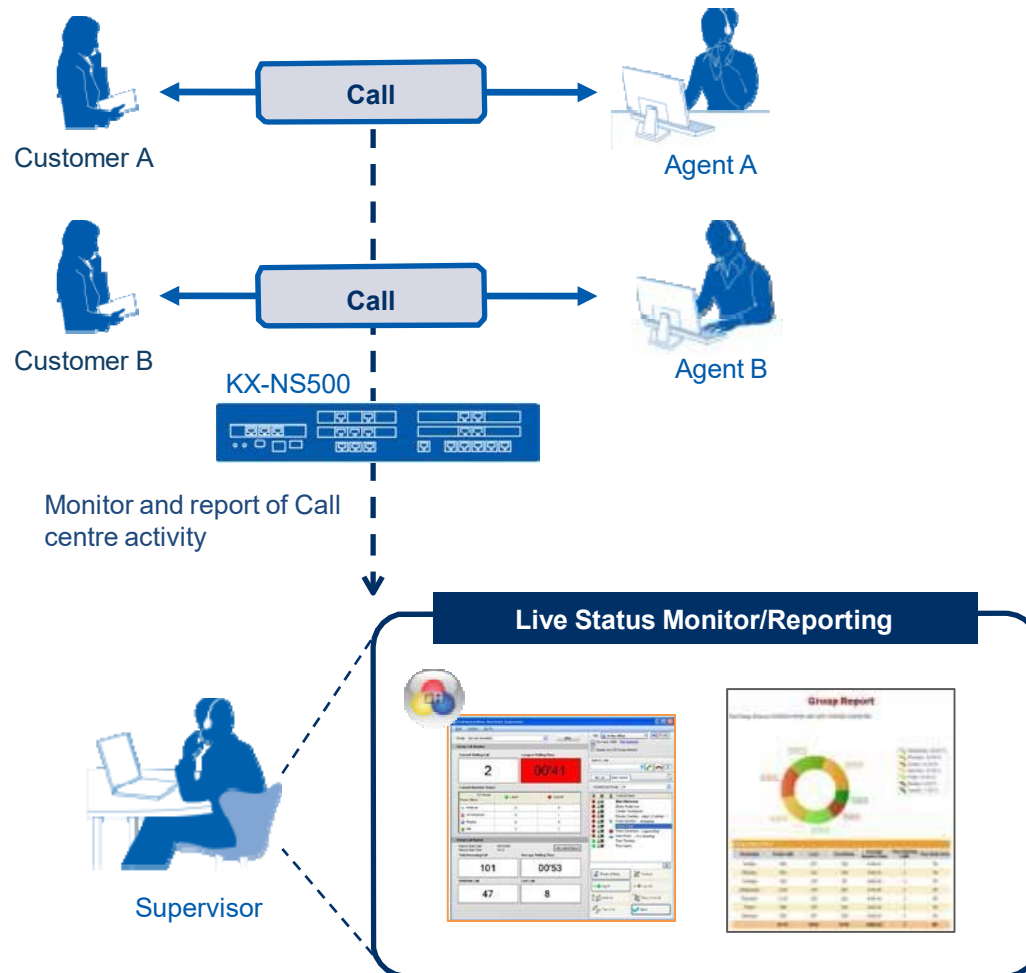

- Analyze the status of calls and any problems to improve customer service.
- Save the status of calls as data.

### Related functions

**Call Centre Solution** - For details, see page 37-42, 71